

SHUTTLEWORTH EXHAUST SYSTEMS

www.shuttleworthexhaust.com

Shuttleworth Exhaust Systems
London, Ontario Canada
1-800-835-3831

Shuttleworth Exhaust Systems
Reno, Nevada USA
1-800-331-9247

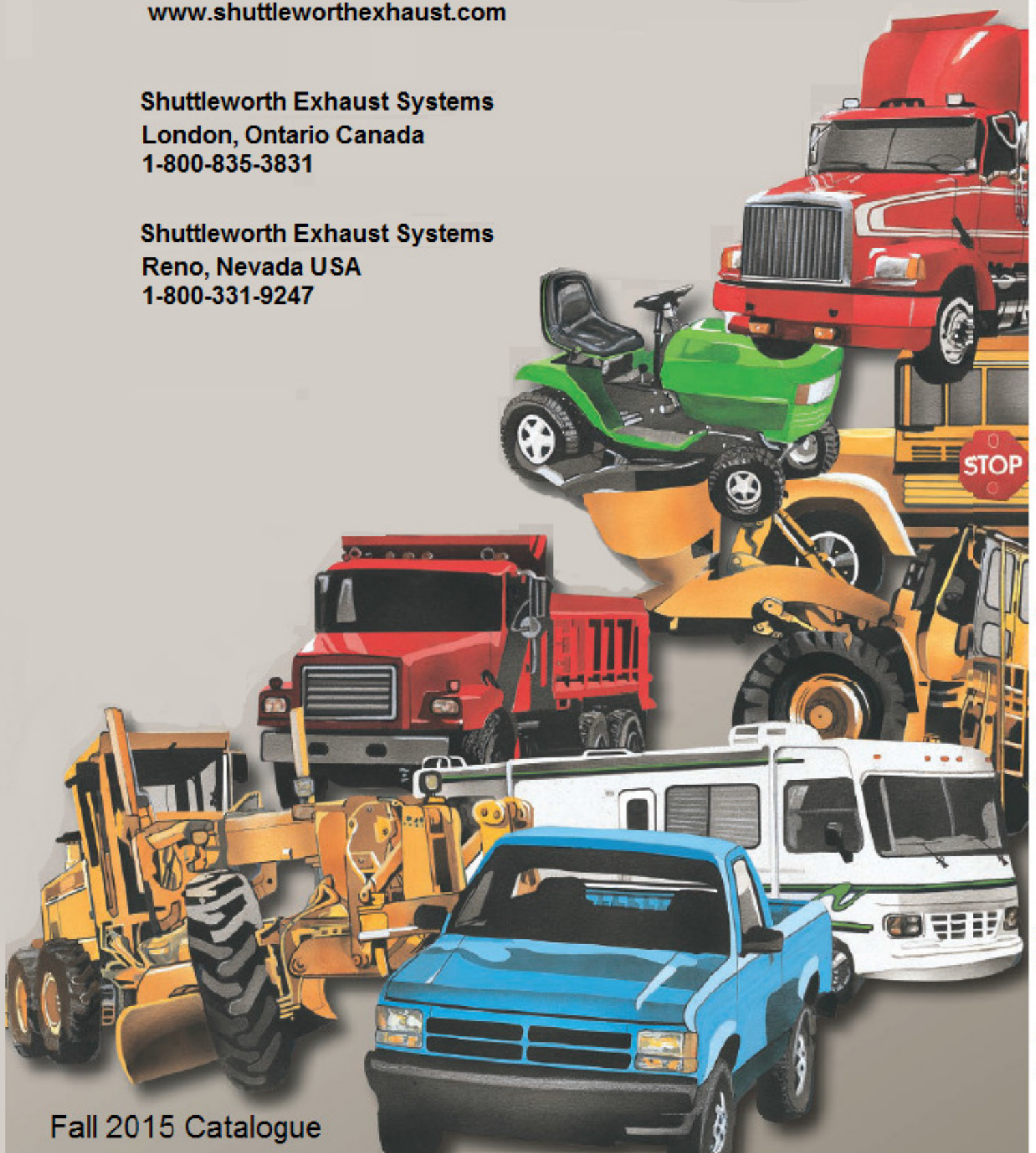

The Heavy Duty Exhaust Experts for Nearly 60 Years!

TABLE OF CONTENTS

Introduction	
Characteristics Legend	2
<hr/>	
Elbows, Stacks & Connectors	
Elbows	3
Y Pipes	10
Split-T Pipes and Tilt Cab Connectors	11
Connectors	12
Stacks	15
<hr/>	
Rain Caps & Clamps	
Rain Caps	20
Mounting Brackets	21
Clamps	22
V-Band Clamps	25
<hr/>	
Guards & Tubing	
Flex Tubing	26
Straight Tubing	28
Muffler Guards & Clamp Kits	29
Grab Handles	30
<hr/>	
Air Intake Parts	
Rubber Elbows	31
Rubber Hump Hoses & Reducers	33
Air Inlet Clamps	34
<hr/>	
Performance Exhaust	
Dodge, Ford and GMC 4" Performance Pick Up Systems	35
<hr/>	
Hood Hooks, Battery Box Latch Kits & Fenders	
Battery Box Latch Kits	36
Rubber Hooks	37
Metal Hardware	38
<hr/>	
Mufflers	
Type 1 Mufflers	40
Type 2 Mufflers	43
Type 3 Mufflers	45
Type 4 Mufflers	46
Type 6 Mufflers	47
Type 9 Mufflers	48
Type 10 Mufflers	49
Type 12 & Type 13 Mufflers	50
Special Mufflers	51
Cross Reference Index	54
Fax Back Forms	56
Notes	57

ELBOWS
STACKS
CONNECTORS

RAIN CAPS
& CLAMPS

GUARDS
& TUBING

AIR INTAKE
PARTS

PERFORMANCE
EXHAUST

HOOD HOOKS
& FENDERS

MUFFLERS



The Heavy Duty Exhaust Experts for Nearly 60 Years!

www.shuttleworthexhaust.com

Since 1958 Shuttleworth has been a leader in the design and manufacture of muffler and exhaust components for the heavy duty after market. As an independent family run business, we take great pride in delivering high quality products, competitive pricing and **Exceptional Customer Service.**

Our library of designs contains over 5000 drawings, we are continually innovating and adding new content and we can do complete custom design and manufacturing -- **If you cannot find what you are looking for in our catalogue - call us!**

For live customer service:

London, Ontario: 1-800-835-3831
Reno, Nevada: 1-800-331-9247

A little bit about us...

We proudly manufacture in North America with 80,000 sq ft of combined capacity in London Ontario Canada and Reno, Nevada USA. All of our components and accessories are sourced from only among the industry's best suppliers that meet our standards for quality and performance.

We offer the following heavy-duty air-flow and specialty products and services:

- Mufflers including comprehensive crossover programs and complete custom design/fabrication services for any size system or application
- Exhaust and air-intake tubing, elbows, clamps and accessories
- Complex tube bending, elbows and components for specialty applications with a wide range of sizes in cold rolled, aluminized and stainless steel
- Distribution of the latest Catalytic and DPF exhaust technologies including custom integration into muffler systems/casings

How to find us...

Shuttleworth Exhaust Canada (SES)

Shuttleworth Exhaust
3526 White Oak Road
London ON N6E 2Z9
Canada

Tel: 1-800-835-3831
Tel: 1-519-681-1180
Fax: 1-519-681-9822

sales@shuttleworthexhaust.com

Shuttleworth Exhaust USA (SES USA)

Shuttleworth Exhaust
4910 Longley Lane Suite 103
Reno NV 89502
USA

Tel: 1-800-331-9247
Tel: 1-775-827-3400
Fax: 1-775-827-1670

ussales@shuttleworthexhaust.com

CHARACTERISTIC LEGEND

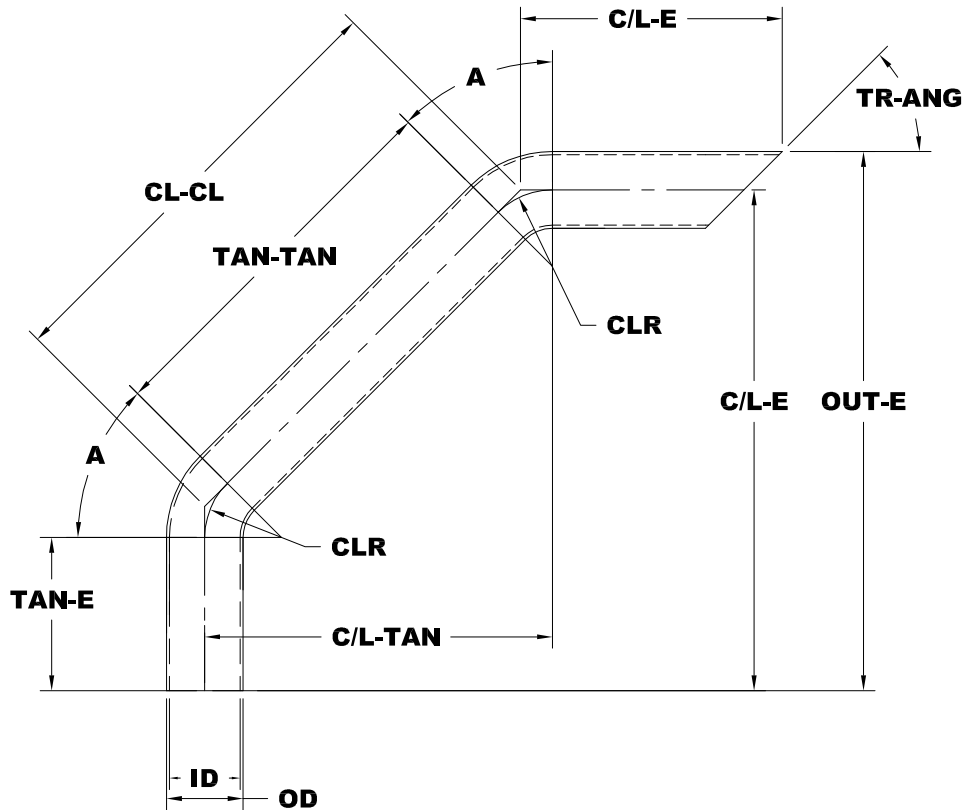

A	ANGLE
C/L-E	CENTERLINE TO END
CLR	CENTERLINE RADIUS
GA	MATERIAL THICKNESS
ID	INSIDE DIAMETER
OD	OUTSIDE DIAMETER
OUT-E	OUTSIDE TO END
TAN-TAN	TANGENT-TANGENT
TAN-E	TANGENT-END
CL-CL	CENTERLINE TO CENTERLINE
TR-ANG	TRIM ANGLE

**PLEASE CONTACT US FOR QUOTES ON CUSTOM BENDING REQUIREMENTS
AVAILABLE IN ALUMINIZED, 304 STAINLESS STEEL AND COLD ROLLED STEEL**

**ELBOWS
STACKS
CONNECTORS**

**RAIN CAPS
& CLAMPS**

**GUARDS
& TUBING**

**AIR INTAKE
PARTS**

**PERFORMANCE
EXHAUST**

**HOOD HOOKS
& FENDERS**

MUFFLERS

**ELBOWS
STACKS
CONNECTORS**

**RAIN CAPS
& CLAMPS**

**GUARDS
& TUBING**

**AIR INTAKE
PARTS**

**PERFORMANCE
EXHAUST**

**HOOD HOOKS
& FENDERS**

MUFFLERS

**STANDARD 90 DEGREE ELBOWS
PLAIN END**

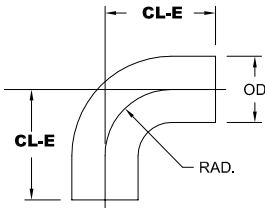

MILL	CHROME	ALUMINIZED	DIA	CLR	C/L-E	ANGLE
1-200 PE	—	431-200 PE	2.0"	4.0	6.0	90
1-250 PE	—	431-250 PE	2.5"	4.0	6.50	90
—	—	431-250-12	2.5"	4.0	12.0	90
1-300 PE	—	431-300 PE	3.0"	6.0	8.0	90
1-350 PE	—	431-350 PE	3.5"	7.0	9.0	90
1-400 PE	—	431-400 PE	4.0"	8.0	11.0	90
1-416 PE	401-416 PE	431-416 PE	4.0"	8.0	16.0	90
1-508 PE	401-508 PE	431-508 PE	5.0"	8.0	12.0	90
1-512 PE	401-512 PE	431-512 PE	5.0"	10.0	14.5	90
1-515 PE	401-515 PE	431-515 PE	5.0"	8.0	15.0	90
1-518 PE	401-518 PE	431-518 PE	5.0"	8.0	18.0	90
1-617 PE	401-617 PE	431-617 PE	6.0"	10.0	17.0	90

**STANDARD 90 DEGREE ELBOWS
EXPANDED & SLOTTED**

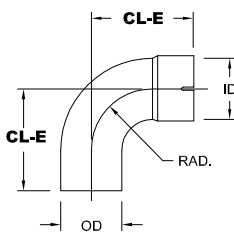

MILL	CHROME	ALUMINIZED	DIA	CLR	C/L-E	ANGLE
1-200	—	431-200	2.0"	4.0	6.0	90
1-250	—	431-250	2.5"	4.0	6.50	90
1-300	—	431-300	3.0"	6.0	8.0	90
1-350	—	431-350	3.5"	7.0	9.0	90
1-400	—	431-400	4.0"	8.0	11.0	90
—	—	431-410	4.0"	6.0	10.0	90
1-416	—	431-416	4.0"	8.0	16.0	90
1-508	401-508	431-508	5.0"	8.0	12.0	90
1-512	—	431-512	5.0"	10.0	14.5	90
1-515	—	431-515	5.0"	8.0	15.0	90
1-518	401-518	431-518	5.0"	8.0	18.0	90
1-617	401-617	431-617	6.0"	10.0	17.0	90

**PLEASE CONTACT US FOR QUOTES ON CUSTOM BENDING REQUIREMENTS
AVAILABLE IN ALUMINIZED, 304 STAINLESS STEEL AND COLD ROLLED STEEL**

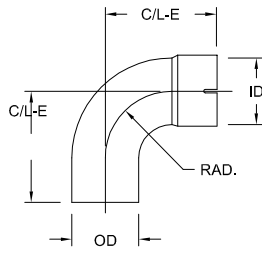
SHORT RADIUS 90 DEG ELBOWS E & S

MILL	CHROME	ALUMINIZED	DIA	CLR	CL/E	ANGLE
4-202	—	434-202	2.0"	2.0"	4.0"	90
4-252	—	434-252	2.5"	2.5"	5.0"	90
4-302	—	434-302	3.0"	3.0"	5.0"	90
4-352	—	434-352	3.5"	3.5"	5.5"	90
4-402	404-402	434-402	4.0"	4.0"	6.0"	90
4-446	—	434-446	4.0"	4.0"	10.0,8.0	90
4-503	404-503	434-503	5.0"	5.5"	7.5"	90
4-509	—	434-509	5.0"	5.5"	10.0"	90
4-515	404-515	434-515	5.0"	5.5"	15.0"	90
4-518	404-518	434-518	5.0"	5.5"	18.0"	90
4-604	404-604	434-604	6.0"	6.0"	10.0	90

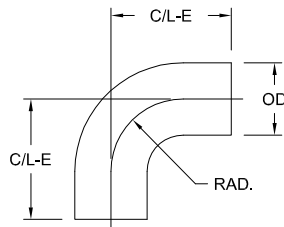
SHORT RADIUS 90 DEGREE ELBOWS PLAIN END

MILL	CHROME	ALUMINIZED	DIA	CLR	CL/E	ANGLE
4-202 PE	—	434-202 PE	2.0"	2.0"	4.0"	90
4-252 PE	—	434-252 PE	2.5"	2.5"	5.0"	90
4-302 PE	—	434-302 PE	3.0"	3.0"	5.0"	90
4-352 PE	—	434-352 PE	3.5"	3.5"	5.5"	90
4-402 PE	404-402 PE	434-402 PE	4.0"	4.0"	6.0"	90
4-446 PE	—	434-446 PE	4.0"	4.0"	10.0,8.0	90
4-503 PE	404-503 PE	434-503 PE	5.0"	5.5"	7.5"	90
4-509 PE	—	434-509 PE	5.0"	5.5"	10.0"	90
4-515 PE	—	434-515 PE	5.0"	5.5"	15.0"	90
4-518 PE	—	434-518 PE	5.0"	5.5"	18.0"	90
4-604 PE	404-604 PE	434-604 PE	6.0"	6.0"	10.0	90

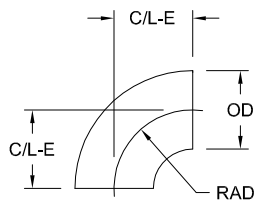
SHORT RADIUS ELBOWS

MILL	CHROME	ALUMINIZED	DIA	CLR	CL/E	ANGLE
3-200	—	433-200	2.0"	2.0"	2.0"	90
3-250	—	433-250	2.5"	2.5"	2.5"	90
3-300	—	433-300	3.0"	3.0"	3.0"	90
3-350	—	433-350	3.5"	3.5"	3.5"	90
3-400	—	433-400	4.0"	4.0"	4.0"	90
3-500	—	433-500	5.0"	5.5"	5.5"	90
3-600	—	433-600	6.0"	6.0"	6.0"	90
3-700	—	—	7.0"	9.0"	9.0"	90
3-745	—	—	7.0"	9.0"	3.75	45
3-800	—	—	8.0"	9.875	9.875	90
3-845	—	—	8.0"	9.875	4.09"	45
3-800-8	—	—	8.0"	8.0"	8.0"	90
3-845-8	—	—	8.0"	8.0"	3.31"	45
3-1090	—	—	10.0"	11.0"	11.0"	90
3-1045	—	—	10.0"	11.0"	4.56"	45
3-1000-10	—	—	10.0"	10.0"	10.0"	90
3-1045-10	—	—	10.0"	10.0"	4.14"	45
3-1200-12	—	—	12.0"	12.0"	12.0"	90
3-1245-12	—	—	12.0"	12.0"	5.0"	45

**PLEASE CONTACT US FOR QUOTES ON CUSTOM BENDING REQUIREMENTS
AVAILABLE IN ALUMINIZED, 304 STAINLESS STEEL AND COLD ROLLED STEEL**

ELBOWS
STACKS
CONNECTORS

RAIN CAPS
& CLAMPS

GUARDS
& TUBING

AIR INTAKE
PARTS

PERFORMANCE
EXHAUST

HOOD HOOKS
& FENDERS

MUFFLERS

STANDARD 45 DEGREE ELBOWS

PLAIN END

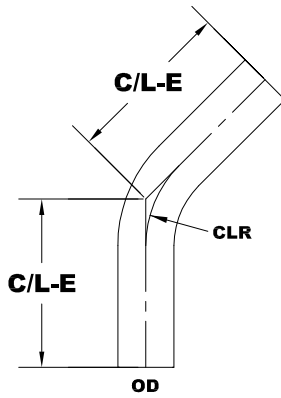

MILL	CHROME	ALUMINIZED	DIA	CLR	C/L-E	ANGLE
2-245 PE	—	432-245 PE	2.0"	4.0	6.0	45
2-2545 PE	—	432-2545 PE	2.5"	4.0	6.0	45
2-345 PE	—	432-345 PE	3.0"	6.0	6.0	45
2-3545 PE	—	432-3545 PE	3.5"	7.0	7.0	45
2-445 PE	—	432-445 PE	4.0"	8.0	6.0	45
—	402-445-8 PE	432-445-8 PE	4.0"	8.0	8.0	45
2-5458 PE	—	432-5458 PE	5.0"	8.0	6.3	45
2-5458-14 PE	402-5458-14 PE	432-5458-14 PE	5.0"	8.0	14.0	45
2-645 PE	402-645 PE	432-645 PE	6.0	10.0	10.0	45

EXPANDED & SLOTTED

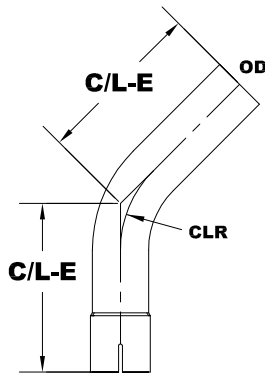

MILL	CHROME	ALUMINIZED	DIA	CLR	C/L-E	ANGLE
2-245	—	432-245	2.0"	4.0	6.0	45
2-2545	—	432-2545	2.5"	4.0	6.0	45
2-345	—	432-345	3.0"	6.0	6.0	45
2-3545	—	432-3545	3.5"	7.0	7.0	45
2-445	402-445	432-445	4.0"	8.0	6.0	45
—	—	432-445-8	4.0"	8.0	8.0	45
—	402-445-12	432-445-12	4.0"	6.0	12.0	45
2-5458	—	432-5458	5.0"	8.0	6.3	45
2-5458-14	402-5458-14	432-5458-14	5.0"	8.0	14.0	45
2-645	402-645	432-645	6.0	10.0	10.0	45

**PLEASE CONTACT US FOR QUOTES ON CUSTOM BENDING REQUIREMENTS
AVAILABLE IN ALUMINIZED, 304 STAINLESS STEEL AND COLD ROLLED STEEL**

**ELBOWS
STACKS
CONNECTORS**

**RAIN CAPS
& CLAMPS**

**GUARDS
& TUBING**

**AIR INTAKE
PARTS**

**PERFORMANCE
EXHAUST**

**HOOD HOOKS
& FENDERS**

MUFFLERS

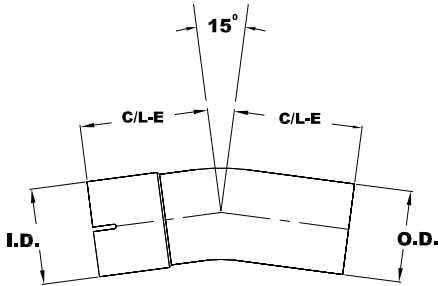

STANDARD 15 DEGREE ELBOWS E & S

MILL	ALUMINIZED	O.D.	I.D.	C/L-E	RAD.
2-4015	432-4015	4"	4.03"	6"	8"
2-5015	432-5015	5"	5.03"	6"	8"

2-4015

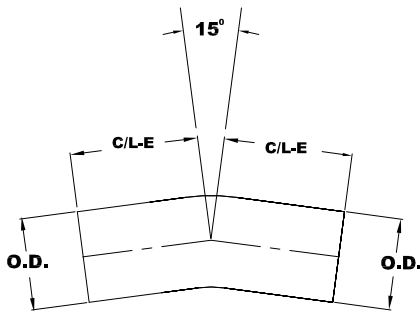

STANDARD 15 DEG ELBOWS PLAIN END

MILL	ALUMINIZED	O.D.	C/L-E	RAD.
2-4015PE	432-4015PE	4"	6"	8"
2-5015PE	432-5015PE	5"	6"	8"

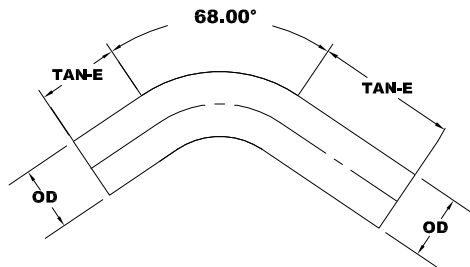

STANDARD 68 DEG ELBOWS

MILL	CHROME	ALUMINIZED	O.D.	TAN-E
1-568 PE	401-568 PE	431-568 PE	5"	4" & 5"

**PLEASE CONTACT US FOR QUOTES ON CUSTOM BENDING REQUIREMENTS
AVAILABLE IN ALUMINIZED, 304 STAINLESS STEEL AND COLD ROLLED STEEL**

ELBOWS
STACKS
CONNECTORS

KENWORTH ELBOWS

INTERCHANGE K180-14766		
MILL	ALUMINIZED	CHROME
1-589045	431-589045	401-589045

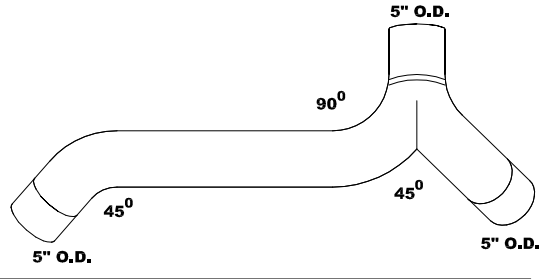

RAIN CAPS
& CLAMPS

INTERCHANGE K180-14764 L OR R		
MILL	ALUMINIZED	CHROME
4-45545 L OR R	434-45545 L OR R	404-45545 L OR R

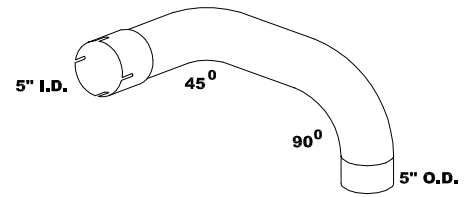

GUARDS
& TUBING

INTERCHANGE K180-12953 L OR R		
MILL	ALUMINIZED	CHROME
1-5823 L OR R	431-5823 L OR R	401-5823 L OR R

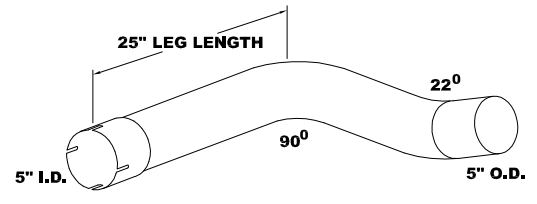

AIR INTAKE
PARTS

INTERCHANGE K180-10742 L OR R		
MILL	ALUMINIZED	CHROME
1-5822 L OR R	431-5822 L OR R	401-5822 L OR R

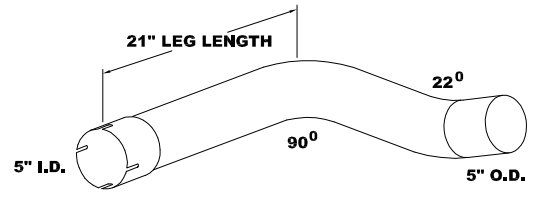

PERFORMANCE
EXHAUST

INTERCHANGE K180-11496		
MILL	ALUMINIZED	CHROME
4-446 PE	434-446 PE	404-446 PE

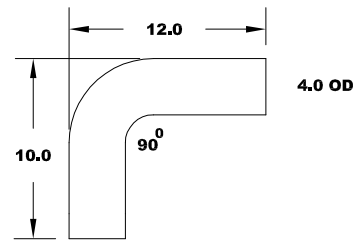

HOOD HOOKS
& FENDERS

INTERCHANGE		
MILL	ALUMINIZED	CHROME
4-402 PE	434-402 PE	404-402 PE

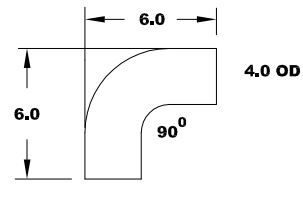

MUFFLERS

**PLEASE CONTACT US FOR QUOTES ON CUSTOM BENDING REQUIREMENTS
AVAILABLE IN ALUMINIZED, 304 STAINLESS STEEL AND COLD ROLLED STEEL**

FREIGHTLINER ELBOWS

INTERCHANGE FL04-9831-002		
MILL	ALUMINIZED	CHROME
4-545	434-545	404-545

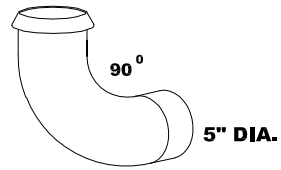

INTERCHANGE FLO4-9829-000		
MILL	ALUMINIZED	CHROME
4-544	434-544	404-544

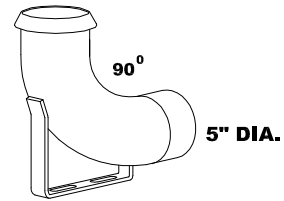

INTERCHANGE FL04-9586-13		
MILL	ALUMINIZED	CHROME
4-4313 PE	434-4313 PE	404-4313 PE

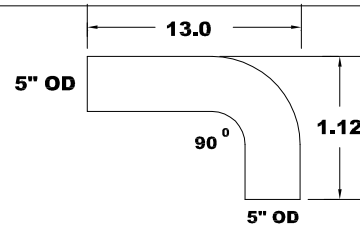

INTERCHANGE FL04-9586-15		
MILL	ALUMINIZED	CHROME
4-4315 PE	434-4315 PE	404-4315 PE

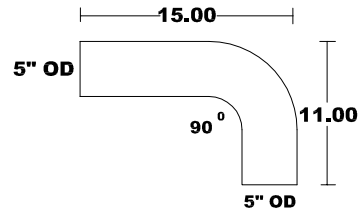

INTERCHANGE FL04-12099		
MILL	ALUMINIZED	CHROME
4-5100 PE	434-5100 PE	404-5100 PE

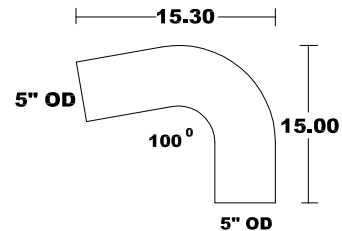

**PLEASE CONTACT US FOR QUOTES ON CUSTOM BENDING REQUIREMENTS
AVAILABLE IN ALUMINIZED, 304 STAINLESS STEEL AND COLD ROLLED STEEL**

**ELBOWS
STACKS
CONNECTORS**

PETERBILT ELBOWS

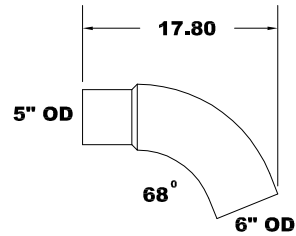

INTERCHANGE		
MILL	ALUMINIZED	CHROME
1-5668 PE	431-5668 PE	401-5668 PE

**RAIN CAPS
& CLAMPS**

**GUARDS
& TUBING**

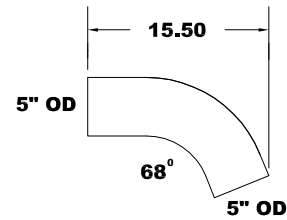

INTERCHANGE 14-1726		
MILL	ALUMINIZED	CHROME
1-568 PE	431-568 PE	401-568 PE

**AIR INTAKE
PARTS**

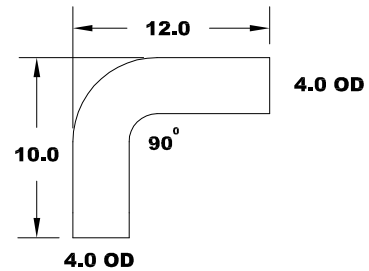

INTERCHANGE 14-08527		
MILL	ALUMINIZED	CHROME
4-446 PE	434-446 PE	404-446 PE

**PERFORMANCE
EXHAUST**

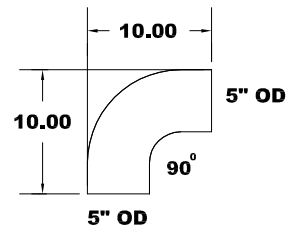

INTERCHANGE 14-08525		
MILL	ALUMINIZED	CHROME
4-503 PE	434-503 PE	404-503 PE

**HOOD HOOKS
& FENDERS**

MUFFLERS

**PLEASE CONTACT US FOR QUOTES ON CUSTOM BENDING REQUIREMENTS
AVAILABLE IN ALUMINIZED, 304 STAINLESS STEEL AND COLD ROLLED STEEL**

PETERBILT Y PIPES

ELBOWS
STACKS
CONNECTORS

RAIN CAPS
& CLAMPS

GUARDS
& TUBING

AIR INTAKE
PARTS

PERFORMANCE
EXHAUST

HOOD HOOKS
& FENDERS

MUFFLERS

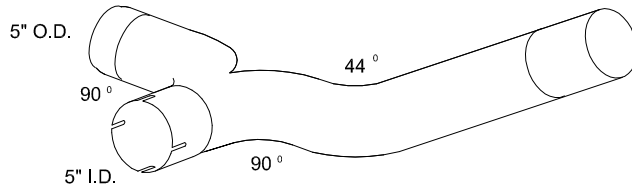

INTERCHANGE		14-04055
MILL	ALUMINIZED	CHROME
1-59044Y	431-59044Y	401-59044Y

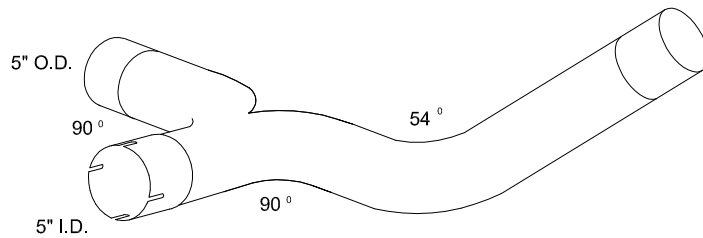

INTERCHANGE		14-12308
MILL	ALUMINIZED	CHROME
1-59054Y	431-59054Y	401-59054Y

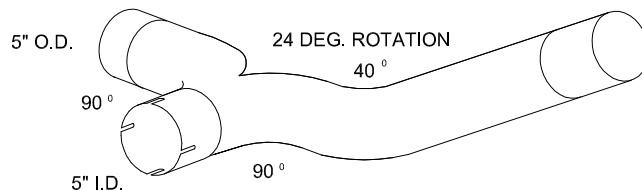

INTERCHANGE		14-13055
MILL	ALUMINIZED	CHROME
1-5904026Y	431-5904026Y	401-5904026Y

**PLEASE CONTACT US FOR QUOTES ON CUSTOM BENDING REQUIREMENTS
AVAILABLE IN ALUMINIZED, 304 STAINLESS STEEL AND COLD ROLLED STEEL**

ELBOWS
STACKS
CONNECTORS

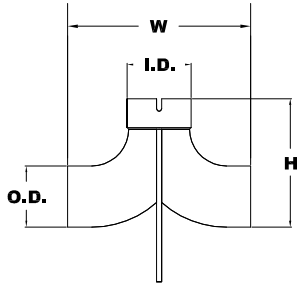

**SPLIT T PIPE
WITH SUPPORT BRACKET**

MILL	CHROME	ALUMINIZED	W	H	ID	OD
16-404	4016-404	4316-404	12"	10"	4.03	4.00
16-555	4016-555	4316-555	15"	10.75"	5.03	5.00
16-5530	4016-5530	4316-5530	30"	15"	5.03	5.00

RAIN CAPS
& CLAMPS

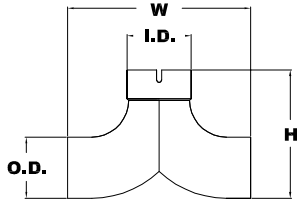

**SPLIT T PIPE
WITHOUT SUPPORT BRACKET**

MILL	CHROME	ALUMINIZED	W	H	ID	OD
16-400	4016-400	4316-400	12"	10"	4.03	4.00
16-500	4016-500	4316-500	15"	10.5"	5.03	5.00

GUARDS
& TUBING

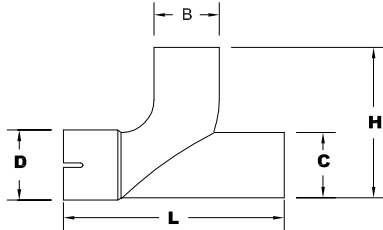

SPLIT PIPES

MILL	CHROME	ALUMINIZED	B	C	D	L	H
16-449011	4016-449011	4316-449011	4.0	4.0	4.03	12.0	9.0
16-559016	4016-559016	4316-559016	5.0	5.0	5.03	15.0	11.0

AIR INTAKE
PARTS

PERFORMANCE
EXHAUST

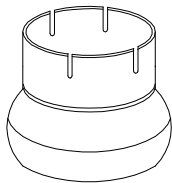

TOP

TILT CAP CONNECTORS

- WEAR PLATE ON BOTH PIECES WILL DOUBLE SERVICE LIFE
- WILL NOT SCORE OR SEIZE
- LINES UP QUICKLY AND POSITIVELY, SEALS PROPERLY.

TILT CAP CONNECTORS

MILL	DESCRIPTION
90-410	4 INCH TOP E/S
90-510	5 INCH TOP E/S
90-411	4 INCH TOP PE
90-511	5 INCH TOP PE
90-420	4 INCH BOTTOM E/S
90-520	5 INCH BOTTOM E/S
90-420 PE	4 INCH BOTTOM PE
90-520 PE	5 INCH BOTTOM PE

HOOD HOOKS
& FENDERS



BOTTOM

MUFFLERS

**PLEASE CONTACT US FOR QUOTES ON CUSTOM BENDING REQUIREMENTS
AVAILABLE IN ALUMINIZED, 304 STAINLESS STEEL AND COLD ROLLED STEEL**

**REDUCING COUPLERS
ID ENDS ARE EXPANDED & SLOTTED**

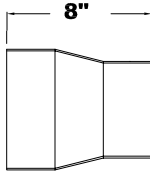

SERIES	SIZE	MILL	ALUMINIZED
2.50 TO 3.00	2.53 ID TO 3.00 ID	15-253	4315-253
	2.53 ID TO 3.00 OD	15-253-1	4315-253-1
	2.50 OD TO 3.03 ID	15-253-2	4315-253-2
	2.50 OD TO 3.00 OD	15-253-3	4315-253-3
3.00 TO 3.50	3.03 ID TO 3.53 ID	15-335	4315-335
	3.03 ID TO 3.50 OD	15-335-1	4315-335-1
	3.00 OD TO 3.53 ID	15-335-2	4315-335-2
	3.00 OD TO 3.50 OD	15-335-3	4315-335-3
3.00 TO 4.00	3.03 ID TO 4.03 ID	15-340	4315-340
	3.03 ID TO 4.00 OD	15-340-1	4315-340-1
	3.00 OD TO 4.03 ID	15-340-2	4315-340-2
	3.00 OD TO 4.00 OD	15-340-3	4315-340-3
3.50 TO 4.00	3.53 ID TO 4.03 ID	15-354	4315-354
	3.53 ID TO 4.00 OD	15-354-1	4315-354-1
	3.50 OD TO 4.03 ID	15-354-2	4315-354-2
	3.50 OD TO 4.00 OD	15-354-3	4315-354-3
4.00 TO 5.00	4.03 ID TO 5.03 ID	15-450	4315-450
	4.03 ID TO 5.00 OD	15-450-1	4315-450-1
	4.00 OD TO 5.03 ID	15-450-2	4315-450-2
	4.00 OD TO 5.00 OD	15-450-3	4315-450-3
4.50 TO 5.00	4.53 ID TO 5.03 ID	15-455	4315-455
	4.53 ID TO 5.00 OD	15-455-1	4315-455-1
	4.50 OD TO 5.03 ID	15-455-2	4315-455-2
	4.50 OD TO 5.00 OD	15-455-3	4315-455-3
5.00 TO 6.00	5.03 ID TO 6.03 ID	15-560	4315-560
	5.03 ID TO 6.00 OD	15-560-1	4315-560-1
	5.00 OD TO 6.03 ID	15-560-2	4315-560-2
	5.00 OD TO 6.00 OD	15-560-3	4315-560-3

**PLEASE CONTACT US FOR QUOTES ON CUSTOM BENDING REQUIREMENTS
AVAILABLE IN ALUMINIZED, 304 STAINLESS STEEL AND COLD ROLLED STEEL**

ELBOWS
STACKS
CONNECTORS

RAIN CAPS
& CLAMPS

GUARDS
& TUBING

AIR INTAKE
PARTS

PERFORMANCE
EXHAUST

HOOD HOOKS
& FENDERS

MUFFLERS

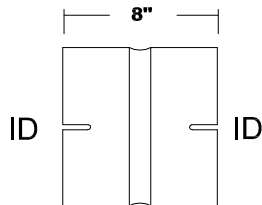
STRAIGHT TUBE COUPLERS**ID ENDS ARE EXPANDED & SLOTTED****ID-ID**

MILL	ALUMINIZED	ID
13-902	4313-902	2.03
13-9225	4313-9225	2.253
13-925	4313-925	2.53
13-903	4313-903	3.03
13-935	4313-935	3.53
13-904	4313-904	4.03
13-945	4313-945	4.53
13-905	4313-905	5.03
13-906	4313-906	6.03
13-907	4313-907	7.03

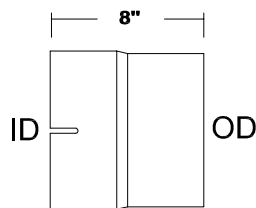
**ID-OD**

MILL	ALUMINIZED	ID	OD
14-020	4314-020	2.03	2.00
14-0225	4314-0225	2.253	2.25
14-025	4314-025	2.53	2.50
14-030	4314-030	3.03	3.00
14-035	4314-035	3.53	3.50
14-040	4314-040	4.03	4.00
14-045	4314-045	4.53	4.50
14-050	4314-050	5.03	5.00
14-060	4314-060	6.03	6.00

**PLEASE CONTACT US FOR QUOTES ON CUSTOM BENDING REQUIREMENTS
AVAILABLE IN ALUMINIZED, 304 STAINLESS STEEL AND COLD ROLLED STEEL**

FLARED FLANGES

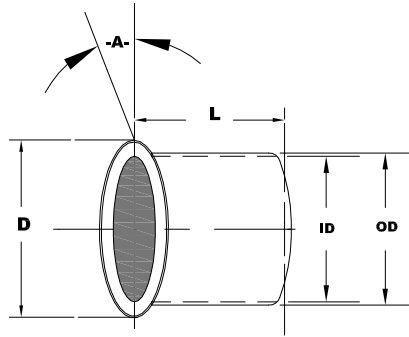

MILL	ALUMINIZED	V-BAND CLAMP	D	L	A	OD	ID	MFG. REF NO.
88-300	4388-300	88-306	3.62	6	20 DEG	3.0		DIESEL MANIFOLD
88-302	4388-302	88-306	3.50	6	45 DEG	3.0		D.D. 53 SERIES
88-345	4388-345	88-306	3.56	6	45 DEG		3.0	D.D. 53 SERIES
88-350	4388-350	88-356	4.25	6	20 DEG		3.53	5108831
88-352	4388-352	88-407	4.00	6	20 DEG	3.5		CAT 3208-T
88-353	4388-353	88-419	4.00	6	45 DEG	3.5		DETROIT DIESEL
88-354	4388-354	88-419	4.00	6	45 DEG	3.5	3.53	
88-400	4388-400	88-462	4.75	6	20 DEG		4.03	5138321 DD-8.2
88-413	4388-413	88-469	4.50	6	45 DEG	4.0		CUMMINS
88-414	4388-414	88-469	4.50	6	45 DEG	4.0	4.03	230/250 CUMMINS
88-415	4388-415	88-479	4.780	6	20 DEG		4.03	5138321
88-430	4388-430	88-479	4.61	6	20 DEG	4.03	4.00	MACK 6 CYL
88-503	4388-503	88-569	5.5625	6	22 DEG	5.0		T-50 TURBO
88-504	4388-504	88-569	5.50	6	45 DEG	5.0		CUMMINS
88-505	4388-505	88-569	5.50	6	22 DEG	5.0		CUMMINS
88-510	4388-510	88-569	5.60	6	20 DEG	5.00	5.03	DD 5140347
88-512	4388-512	88-506	5.750	12	20 DEG	4.0 -5.0		T-50 TURBO
88-513	4388-513	88-506	5.750	6	20 DEG	5.0		
88-545	4388-545	88-569	5.50	6	45 DEG	5.0	5.03	CUMMINS

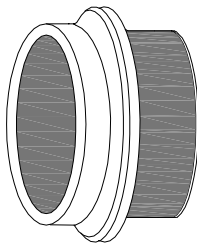

DETROIT DIESEL TURBO EXHAUST
PART NUMBER 88-487 MACHINED TURBO FLANGE
FOR USE WITH DDA ENGINES WITH 4" OR 5" EXHAUST
4" SYSTEM REQUIRES USE OF (14-040 OR 13-904)
REPLACES DDA PART NUMBER 5101814 IN 5"
REPLACES DDA PART NUMBER 5132633 IN 4"

PART NUMBER	V-BAND CLAMP	TURBO APPLICATIONS
88-487	88-516	ALL SCHWITZER DDA TURBOS AIRESEARCH TV8101 T1865 T18A40

PLEASE CONTACT US FOR QUOTES ON CUSTOM BENDING REQUIREMENTS
AVAILABLE IN ALUMINIZED, 304 STAINLESS STEEL AND COLD ROLLED STEEL

ELBOWS
STACKS
CONNECTORS

RAIN CAPS
& CLAMPS

GUARDS
& TUBING

AIR INTAKE
PARTS

PERFORMANCE
EXHAUST

HOOD HOOKS
& FENDERS

MUFFLERS

ELBOWS
STACKS
CONNECTORS**STRAIGHT EXTENSION STACK****SQUARE CUT-PLAIN END**

CHROME	ALUMINIZED	DIA	LENGTH
40-324	4310-324	3 INCH	24"
40-348	4310-348	3 INCH	48"
40-3524	4310-3524	3.5 INCH	24"
40-3548	4310-3548	3.5 INCH	48"
40-418	4310-418	4 INCH	18"
40-424	4310-424	4 INCH	24"
40-436	4310-436	4 INCH	36"
40-460	4310-460	4 INCH	60"
40-524	4310-524	5 INCH	24"
40-536	4310-536	5 INCH	36"
40-548	4310-548	5 INCH	48"
40-560	4310-560	5 INCH	60"
40-660	4310-660	6 INCH	60"

RAIN CAPS
& CLAMPSGUARDS
& TUBINGAIR INTAKE
PARTS**STRAIGHT EXTENSION STACK****SQUARE CUT- EXPANDED & SLOTTED**

CHROME	ALUMINIZED	DIA	LENGTH
4011-324	4311-324	3 INCH	24"
4011-336	4311-336	3 INCH	36"
4011-3524	4311-3524	3.5 INCH	24"
4011-3536	4311-3536	3.5 INCH	36"
4011-418	4311-418	4 INCH	18"
4011-424	4311-424	4 INCH	24"
4011-448	4311-448	4 INCH	48"
4011-460	4311-460	4 INCH	60"
4011-518	4311-518	5 INCH	18"
4011-524	4311-524	5 INCH	24"
4011-536	4311-536	5 INCH	36"
4011-548	4311-548	5 INCH	48"
4011-560	4311-560	5 INCH	60"
4011-624	4311-624	6 INCH	24"

PERFORMANCE
EXHAUSTHOOD HOOKS
& FENDERS

MUFFLERS

**PLEASE CONTACT US FOR QUOTES ON CUSTOM BENDING REQUIREMENTS
AVAILABLE IN ALUMINIZED, 304 STAINLESS STEEL AND COLD ROLLED STEEL**

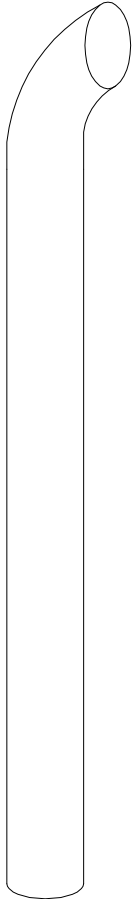
CURVED EXTENSION STACK**PLAIN END**

CHROME	ALUMINIZED	DIA	LENGTH
4017-318	4317-318	3 INCH	18"
4017-324	4317-324	3 INCH	24"
4017-3524	4317-3524	3.5 INCH	24"
4017-3536	4317-3536	3.5 INCH	36"
4017-418	4317-418	4 INCH	18"
4017-424	4317-424	4 INCH	24"
4017-436	4317-436	4 INCH	36"
4017-448	4317-448	4 INCH	48"
4017-460	4317-460	4 INCH	60"
4017-518	4317-518	5 INCH	18"
4017-524	4317-524	5 INCH	24"
4017-536	4317-536	5 INCH	36"
4017-548	4317-548	5 INCH	48"
4017-560	4317-560	5 INCH	60"
4017-572	—————	5 INCH	72"
4017-596	—————	5 INCH	96"
4017-624	4317-624	6 INCH	24"
4017-648	4317-648	6 INCH	48"
4017-660	4317-660	6 INCH	60"

**PLEASE CONTACT US FOR QUOTES ON CUSTOM BENDING REQUIREMENTS
AVAILABLE IN ALUMINIZED, 304 STAINLESS STEEL AND COLD ROLLED STEEL**

ELBOWS
STACKS
CONNECTORSRAIN CAPS
& CLAMPSGUARDS
& TUBINGAIR INTAKE
PARTSPERFORMANCE
EXHAUSTHOOD HOOKS
& FENDERS

MUFFLERS

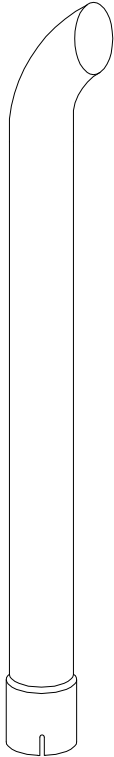
**CURVED EXTENSION STACK
EXPANDED & SLOTTED**

CHROME	ALUMINIZED	DIA	LENGTH
4012-318	4312-318	3 INCH	18"
4012-324	4312-324	3 INCH	24"
4012-336	4312-336	3 INCH	36"
4012-348	4312-348	3 INCH	48"
4012-3518	4312-3518	3.5 INCH	18"
4012-3536	4312-3536	3.5 INCH	36"
4012-3548	4312-3548	3.5 INCH	48"
4012-412	4312-412	4 INCH	12"
4012-418	4312-418	4 INCH	18"
4012-424	4312-424	4 INCH	24"
4012-436	4312-436	4 INCH	36"
4012-448	4312-448	4 INCH	48"
4012-460	4312-460	4 INCH	60"
4012-472	-----	4 INCH	72"
4012-484	-----	4 INCH	84"
4012-496	-----	4 INCH	96"
4012-512	-----	5 INCH	12"
4012-518	4312-518	5 INCH	18"
4012-524	4312-524	5 INCH	24"
4012-536	4312-536	5 INCH	36"
4012-548	4312-548	5 INCH	48"
4012-560	4312-560	5 INCH	60"
4012-572	-----	5 INCH	72"
4012-584	-----	5 INCH	84"
4012-596	-----	5 INCH	96"
4012-5108	-----	5 INCH	108"
4012-5120	-----	5 INCH	120"
4012-624	4312-624	6 INCH	24"
4012-648	4312-648	6 INCH	48"
4012-660	4312-660	6 INCH	
4012-672	-----	6 INCH	
4012-696	-----	6 INCH	

**PLEASE CONTACT US FOR QUOTES ON CUSTOM BENDING REQUIREMENTS
AVAILABLE IN ALUMINIZED, 304 STAINLESS STEEL AND COLD ROLLED STEEL**

**PLAIN END****STRAIGHT EXTENSION STACK MITRE CUT**

CHROME	DIA	LENGTH
420-418	4 INCH	18"
420-436	4 INCH	36"
420-524	5 INCH	24"
420-536	5 INCH	36"
420-548	5 INCH	48"
420-560	5 INCH	60"
420-636	6 INCH	36"
420-660	6 INCH	60"

**EXPANDED & SLOTTED****STRAIGHT EXTENSION STACK MITRE CUT**

CHROME	DIA	LENGTH
4211-424	4 INCH	24"
4211-524	5 INCH	24"
4211-536	5 INCH	36"
4211-572	5 INCH	72"
4211-584	5 INCH	84"
4211-596	5 INCH	96"
4211-648	6 INCH	48"
4211-696	6 INCH	96"
4211-6108	6 INCH	108"

**PLEASE CONTACT US FOR QUOTES ON CUSTOM BENDING REQUIREMENTS
AVAILABLE IN ALUMINIZED, 304 STAINLESS STEEL AND COLD ROLLED STEEL**

ELBOWS
STACKS
CONNECTORS

RAIN CAPS
& CLAMPS

GUARDS
& TUBING

AIR INTAKE
PARTS

PERFORMANCE
EXHAUST

HOOD HOOKS
& FENDERS

MUFFLERS

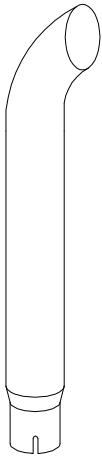

**CURVED REDUCED EXTENSION STACK
ONE PIECE-NO WELDS-CHROME PLATED**

EXPANDED & SLOTTED

CHROME	DIA	LENGTH
4012-5648	6 INCH TO 5 INCH ID	48"
4012-5660	6 INCH TO 5 INCH ID	60"
4012-5684	6 INCH TO 5 INCH ID	84"
4012-5696	6 INCH TO 5 INCH ID	96"
4012-56108	6 INCH TO 5 INCH ID	108"
4012-56120	6 INCH TO 5 INCH ID	120"

**STRAIGHT REDUCED MITRE CUT EXTENSION STACK
ONE PIECE-NO WELDS-CHROME PLATED**

PLAIN END

CHROME	DIA	LENGTH
420-5648	6 INCH TO 5 INCH OD	48"
420-5660	6 INCH TO 5 INCH OD	60"

**STRAIGHT REDUCED MITRE CUT EXTENSION STACK
ONE PIECE-NO WELDS-CHROME PLATED**

EXPANDED & SLOTTED

CHROME	DIA	LENGTH
4211-5672	6 INCH TO 5 INCH ID	72"
4211-5696	6 INCH TO 5 INCH ID	96"
4211-56108	6 INCH TO 5 INCH ID	108"
4211-56120	6 INCH TO 5 INCH ID	120"

**PLEASE CONTACT US FOR QUOTES ON CUSTOM BENDING REQUIREMENTS
AVAILABLE IN ALUMINIZED, 304 STAINLESS STEEL AND COLD ROLLED STEEL**

- **PRECISION BALANCED VANE ASSEMBLY**
(Meets engine manufacturers exhaust specifications)
- **BRONZE BUSHING AND BEARING**
(Long life and trouble free operation)
- **DUEL VANE COUNTERBALANCE**
(Rugged anti warp design)
- **WELDED LID ASSEMBLY**
(Stands up under severe usage)
- **HEAVY DUTY PLATING THROUGHOUT**

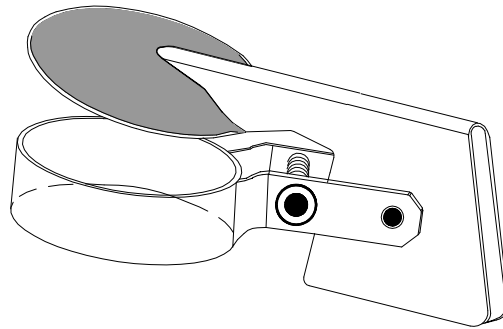

STANDARD

ZINC	CHROME	SIZE
9-150		1.50"
9-175		1.75"
9-200		2.00"
9-225		2.25
9-250		2.50"
9-275		2.75"
9-300		3.00"
9-350		3.50"
9-400	409-400	4.00"
9-450		4.50"
9-500	409-500	5.00"
9-525		5.25"
9-550		5.50"
9-575		5.75"
9-600		6.00"
9-6625		6.625"
9-800		8.00"

SILENT STYLE

ZINC	SIZE
9-300 SL	3.00"
9-350 SL	3.50"
9-400 SL	4.00"
9-500 SL	5.00"
9-600 SL	6.00"

**PLEASE CONTACT US FOR QUOTES ON CUSTOM BENDING REQUIREMENTS
AVAILABLE IN ALUMINIZED, 304 STAINLESS STEEL AND COLD ROLLED STEEL**

ELBOWS
STACKS
CONNECTORS

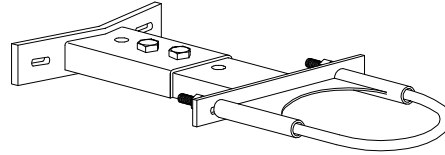
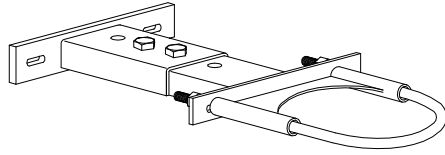

FLAT-52-SERIES ZINC PLATED

CURVED -51-SERIES ZINC PLATED

PART NO.	DESCRIPTION	PART NO.	DESCRIPTION
58-52-4	4" FLAT	58-51-4	4" CURVED
58-52-5	5" FLAT	58-51-5	5" CURVED
58-52-6	6" FLAT	58-51-6	6" CURVED

RAIN CAPS
& CLAMPS

GUARDS
& TUBING

FLAT-53-SERIES CHROME PLATED

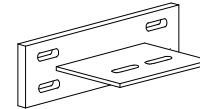
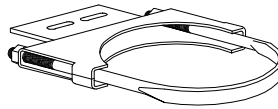
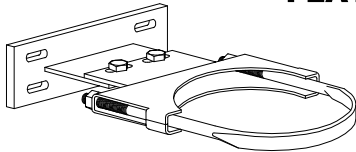

ASSEMBLY

DETAIL 1

DETAIL 2

PART NO.	DESCRIPTION	PART NO.	DESCRIPTION	PART NO.	DESCRIPTION
58-53-4	4" FLAT	58-53-4 D1	4" FLAT	58-53-D2	MOUNTING BASE
58-53-5	5" FLAT	58-53-5 D1	5" FLAT		
58-53-6	6" FLAT	58-53-6 D1	6" FLAT		

AIR INTAKE
PARTS

UNIVERSAL MUFFLER MOUNTING BRACKET.

PART NO.	DESCRIPTION	PART NO.	DESCRIPTION
350-047	6" ROUND	350-060	13" ROUND
350-048	7" ROUND	350-061	14" ROUND
350-049	8" ROUND	350-064	16" ROUND
350-050	8.5" ROUND	350-067	19" ROUND
350-051	9" ROUND	350-056	8" X 11" HORIZONTAL OVAL
350-052	10" ROUND	350-057	10" X 15" VERTICLE OVAL
350-054	11" ROUND	350-058	10" X 15" HORIZONTAL OVAL
350-055	12" ROUND	350-059	8" X 11" VERTICLE OVAL

PERFORMANCE
EXHAUST

HOOD HOOKS
& FENDERS

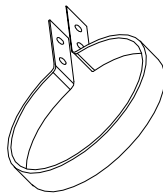

ROUND

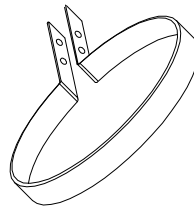

HORIZONTAL OVAL

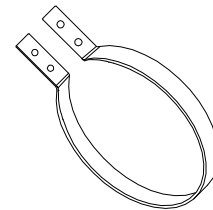

VERTICLE OVAL

MUFFLERS

Sealmaster Clamps

- SEALMASTER CLAMPS CAN BE USED TO CONNECT OVERLAPPING ID FLEXIBLE METAL HOSE TO OD METAL TUBING OR TO JOIN SLOTTED OR UNSLOTTED OD TUBING TO ID TUBING.
- THE SEALMASTER CLAMP DESIGN PROVIDES SUPERIOR STRENGTH AND DURABILITY WHILE ENSURING A TIGHT WELL SEALED JOINT.

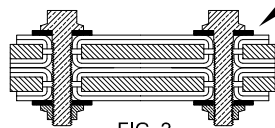
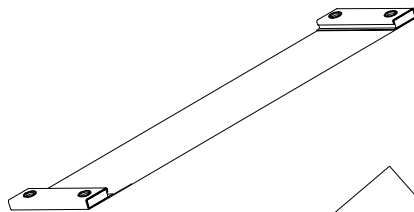
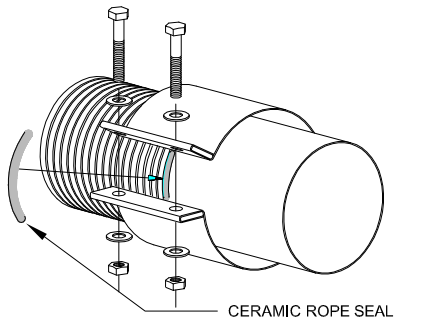

FIG. 2

HIGH STRENGTH FORMED GROMMETS FLARED INTO THE DRAW BAR PROVIDE EXCEPTIONAL STRENGTH AND DURABILITY FOR DRAWING THE 24 GA. STAINLESS STEEL BAND AROUND THE WORKPIECE.

FLAT BAND STYLE

STAINLESS	ALUMINIZED	SIZE
66-150	66-150 AL	1.50
66-200	66-200 AL	2.00
66-225	66-225 AL	2.25
66-250	66-250 AL	2.50
66-275	66-275 AL	2.75
66-300	66-300 AL	3.00
66-350	66-350 AL	3.50
66-400	66-400 AL	4.00
66-500	66-500 AL	5.00
66-600	66-600 AL	6.00
66-800	66-800 AL	8.00
66-1000	66-1000 AL	10.00

PREFORMED BAND CLAMPS

STAINLESS	ALUMINIZED	SIZE
66-300 PF	66-300 PFAL	3.00
66-350 PF	66-350 PFAL	3.50
66-400 PF	66-400 PFAL	4.00
66-500 PF	66-500 PFAL	5.00
66-600 PF	66-600 PFAL	6.00

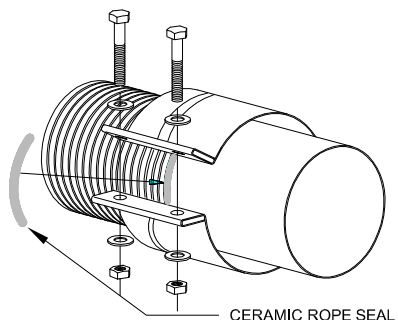

ELBOWS
STACKS
CONNECTORS

RAIN CAPS
& CLAMPS

GUARDS
& TUBING

AIR INTAKE
PARTS

PERFORMANCE
EXHAUST

HOOD HOOKS
& FENDERS

MUFFLERS

Torc-Tite™ WIDE BAND CLAMPS

Torc-Tite preformed clamps provide a strong tightly sealed joint without the need for extra gaskets.

Available in lap joint or butt joint applications.

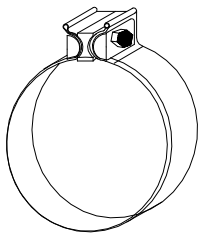
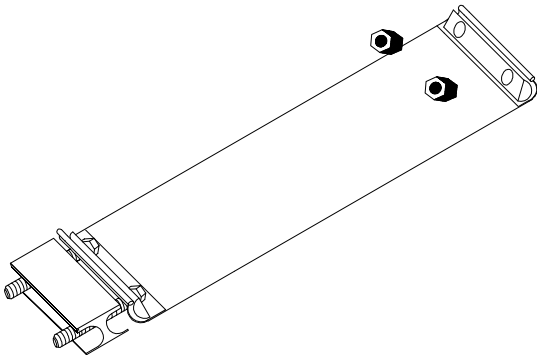
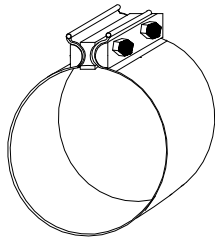
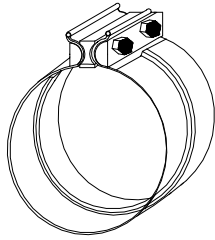

Torc-Tite™ Wide Band Clamps

ALUMINIZED	STAINLESS	JOINT	SIZE
4367-200	67-200	LAP JOINT	2.0"
4367-225	67-225	LAP JOINT	2.25"
4367-250	67-250	LAP JOINT	2.50"
4367-275	67-275	LAP JOINT	2.75"
4367-300	67-300	LAP JOINT	3.00"
4367-350	67-350	LAP JOINT	3.50"
4367-400	67-400	LAP JOINT	4.00"
4367-450	67-450	LAP JOINT	4.50"
4367-500	67-500	LAP JOINT	5.00"
4367-600	67-600	LAP JOINT	6.00"
4368-350	68-350	BUTT JOINT	3.50"
4368-400	68-400	BUTT JOINT	4.00"
4368-450	68-450	BUTT JOINT	4.50"
4368-500	68-500	BUTT JOINT	5.00"
4368-600	68-600	BUTT JOINT	6.00"

EasySeal™ Flat Band Clamp

STAINLESS	SIZE
65-400	4.00"
65-500	5.00"

AccuSeal™ Clamps

ALUMINIZED	STAINLESS	SIZE
4369-200	69-200	2.0"
4369-225	69-225	2.25"
4369-250	69-250	2.50"
4369-275	69-275	2.75"
4369-300	69-300	3.00"
4369-350	69-350	3.50"
4369-400	69-400	4.00"
4369-450	69-450	4.50"
4369-500	69-500	5.00"
4369-600	69-600	6.00"

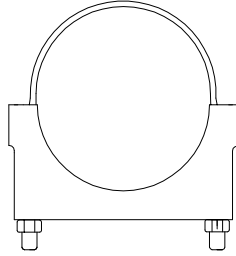

HEAVY-DUTY FLAT U-BOLT CLAMPS

Provides a superior seal on all standard installations of elbows, stacks and couplers. .3125 oversize

MILL	CHROME	ZINC	SIZE
6-230	406-230	426-230	3"
6-235	406-235	426-235	3.5"
6-240	406-240	426-240	4"
6-250	406-250	426-250	5"
6-260	406-260	426-260	6"

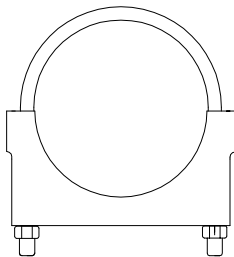

HEAVY-DUTY ROUND U-BOLT CLAMPS

Rugged .3125" oversize for easier installation with exhaust couplers (both straight and flexible). rolled threads for extra long life, strength and ease of installation.

MILL	ZINC	SIZE
6-3150	426-3150	1.5
6-3175	426-3175	1.75
6-320	426-320	2"
6-3225	426-3225	2.25"
6-325	426-325	2.5"
6-3275	426-3275	2.75"
6-330	426-330	3"
6-335	426-335	3.5"
6-340	426-340	4"
6-350	426-350	5"

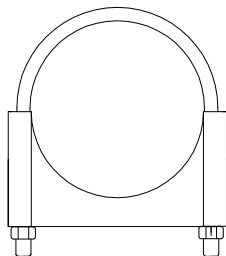

HEAVY-DUTY GUILLOTINE SADDLE CLAMPS

Precision formed metal clamps .375 u-bolt

MILL	ZINC	SIZE
6-530	426-530	3"
6-535	426-535	3.5"
6-540	426-540	4"
6-550	426-550	5"

STAINLESS STEEL, V-BAND TYPE FOR USE WITH LIPPED FLANGES.

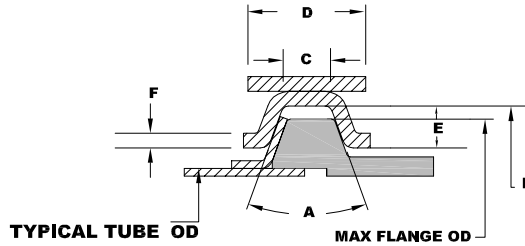
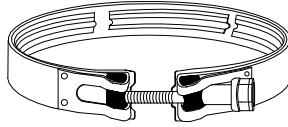

ELBOWS
STACKS
CONNECTORS

RAIN CAPS
& CLAMPS

GUARDS
& TUBING

AIR INTAKE
PARTS

PERFORMANCE
EXHAUST

HOOD HOOKS
& FENDERS

MUFFLERS

TUBE OD	PART NUMBER	APPLICATION	A	B	C	D	E	F	MAX FLANGE OD
2.50"	88-375	FORD 370 & 429 E5HZ-5A231	40°	3.88	.400	1.00	.355	.125	3.75
2.50"	88-287	DD 8.2T-8920206	40°	2.88	.207	.75	.28	.050	2.75
2.75"	88-313	CUMMINS B	40°	3.22	.262	.85	.14	.050	3.13
3.0"	88-365	FORD D9HT-51210-DA	40°	3.87	.425	.88	.31	.075	3.65
3.0"	88-306	DD 6V71	40°	3.82	.207	.88	.28	.080	3.70
3.0"	88-316	CUMMINS V903	40°	3.88	.400	.88	.28	.050	3.76
3.12"	88-384	OE MUFFLER	40°	3.96	.207	.88	.28	.080	3.84
3.50"	88-403	CUMMINS C	40°	4.12	.262	.67	.14	.050	4.03
3.50"	88-407	CAT 3208T	40°	4.19	.400	.88	.28	.050	4.07
3.50"	88-419	IH DT466 & CONNECTOR ENDS	40°	4.31	.207	.88	.28	.080	4.19
3.50"	88-356	DD8V71	40°	4.50	.207	.88	.28	.080	4.38
3.50"	88-414	CUMMINS VT555	40°	4.25	.400	.88	.28	.050	4.14
3.50"	88-326	DD 8.2L,FORD EOHT58281-BA	40°	4.00	.210	.88	.18	.075	3.78
4.0"	88-401	DD 8.2N	40°	4.06	.162	.88	.29	.075	4.61
4.0"	88-406	12V71-6.71	40°	4.49	.207	.75	.28	.080	4.36
4.0"	88-463	CAT 3176T CUMMINS L10	40°	4.75	.400	1.00	.28	.050	4.63
4.0"	88-462	DD8.2T GM 2295978	40°	4.75	.158	.88	.31	.075	4.62
4.0"	88-482	MACK 11ME29	40°	4.94	.181	.75	.28	.062	4.82
4.0"	88-441	SWITZER 4LDE, FLE 4LH,4LS	40°	4.50	.262	.75	.14	.050	4.41
4.0"	88-469	CONNECTOR ENDS	40°	4.81	.207	.88	.28	.080	4.69
4.0"	88-479	DD 6-71	40°	4.91	.293	1.13	.30	.090	4.79
4.0"	88-449	MACK 48RU2341	40°	4.61	.156	.75	.22	.050	4.49
4.0"	88-416	AIRESEARCH 4LF-TEO699	40°	4.30	.188	.75	.23	.050	4.38
4.87"	88-516	DD8V71T	40°	5.25	.262	.75	.14	.050	5.16
5.0"	88-456	AIRESEARCH T-1899-THO8A64	40°	5.43	.262	.75	.14	.050	5.15
5.0"	88-506	CUMMINS T50-VT50	40°	5.88	.400	.88	.28	.050	5.79
5.0"	88-569	CONNECTOR ENDS	40°	5.81	.207	.88	.28	.080	5.69
5.0"	88-575	DD 8V71 SPECIAL MANIFOLD	40°	5.87	.365	.88	.30	.050	5.75
5.0"	88-511	DD 6V71,8V71,12V71	40°	5.86	.293	1.125	.296	.090	5.795



PARTS FLEX TUBE

LONDON, ON 1-800-835-3831

RENO, NV 1-800-331-9247

CUT-AWAY VIEW

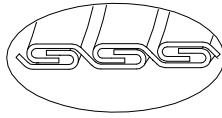

COILS AND STRAIGHT LENGTHS

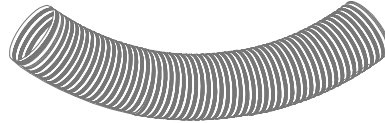

WITH NARROW RIBS FOR
GREATER FLEXIBILITY

ALL METAL FLEX HOSE FEATURES 4 PLY INTERLOCKED CONSTRUCTION

HEAVY WEIGHT GALVANIZED

OUR BEST SELLING GALVANIZED HOSE
UNPACKED 25' COILS OR 10' STRAIGHT LENGTHS .016 TO .019 STRIP

PART NUMBER	ID	OD REF	INSIDE BEND DIA	WEIGHT PER FT.	STRETCHED LENGTH
25-1520	1.50"	1.625"	14.0"	1.1 LB	25'
25-17520	1.75"	1.81"	16.0"	1.1 LB	25'
25-2020	2.00"	2.18"	17.0"	1.2 LB	25'
25-22520	2.25"	2.38"	18.0"	1.4 LB	25'
25-2520	2.50"	2.68"	22.0"	1.5 LB	25'
25-27520	2.75"	2.87"	25.0"	1.7 LB	25'
25-3020	3.00"	3.18"	28.0"	1.8 LB	25'
25-3020-120	3.00"	3.18"	28.0"	1.8 LB	10'
25-3520	3.50"	3.68"	32.0"	2.2 LB	25'
25-3520-120	3.50"	3.68"	32.0"	2.2 LB	10'
25-4020	4.0"	4.18"	34.0"	2.5 LB	25'
25-4020-120	4.0"	4.18"	34.0"	2.5 LB	10'
25-5020	5.0"	5.18"	45.0"	3.1 LB	25'
25-5020-120	5.0"	5.18"	45.0"	3.1 LB	10'
25-6020	6.0"	6.18"	55.0"	3.8 LB	25'
25-6020-120	6.0"	6.18"	55.0"	3.8 LB	10'

STAINLESS STEEL TYPE 304

USE IN APPLICATIONS WHERE HIGH TEMPERATURE IS A FACTOR OR MAXIMUM SERVICE LIFE IS DESIRED.
UNPACKED 25' COILS OR 10' STRAIGHT LENGTHS .016 TO .019 STRIP

PART NUMBER	ID	OD REF	INSIDE BEND DIA	WEIGHT PER FT.	STRETCHED LENGTH
302-2020	2.0"	2.16"	17.0"	1.5 LB	25'
302-2520	2.50"	2.68"	22.0"	1.6 LB	25'
302-3020	3.00"	3.18"	28.0"	1.8 LB	25'
302-3020-120	3.00"	3.18"	28.0"	1.8 LB	10'
302-3520	3.50"	3.68"	32.0"	2.2 LB	25'
302-3520-120	3.50"	3.68"	32.0"	2.2 LB	10'
302-4020	4.0"	4.18"	34.0"	2.5 LB	25'
302-4020-120	4.0"	4.18"	34.0"	2.5 LB	10'
302-5020	5.0"	5.18"	45.0"	3.1 LB	25'
302-5020-120	5.0"	5.18"	45.0"	3.1 LB	10'
302-6020	6.0"	6.18"	55.0"	3.8 LB	25'
302-6020-120	6.0"	6.18"	55.0"	3.8 LB	10'
302-8020-120	8.0"	8.16"	68.0"	4.6 LB	10'
302-1020-120	10.0"	10.16"	90.0"	6.2 LB	10'

ELBOWS
STACKS
CONNECTORS

RAIN CAPS
& CLAMPS

GUARDS
& TUBING

AIR INTAKE
PARTS

PERFORMANCE
EXHAUST

HOOD HOOKS
& FENDERS

MUFFLERS

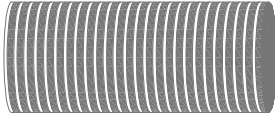
FLEX HOSE CUT LENGTHS

- FLEXIBLE METAL HOSE CUT LENGTHS ARE EASY TO INSTALL AND EASY TO STOCK.
- ALL CUT LENGTHS ARE TRIMMED, DEBURRED AND SPOT WELDED ON BOTH ENDS.

EXTRA HEAVY DUTY GALVANIZED CUT LENGTHS .021 TO .024 STRIP

PART NUMBER	ID	LENGTH
25-4026-12	4.00"	12"
25-4026-18	4.00"	18"
25-4026-24	4.00"	24"
25-4026-36	4.00"	36"
25-5026-12	5.00"	12"
25-5026-18	5.00"	18"
25-5026-24	5.00"	24"
25-5026-36	5.00"	36"

HEAVY WEIGHT GALVANIZED CUT LENGTHS .016 TO .019 STRIP

PART NUMBER	ID	LENGTH
25-4020-12	4.00"	12"
25-4020-18	4.00"	18"
25-4020-24	4.00"	24"
25-4020-36	4.00"	36"
25-5020-12	5.00"	12"
25-5020-18	5.00"	18"
25-5020-24	5.00"	24"
25-5020-36	5.00"	36"

TYPE 304 STAINLESS STEEL CUT LENGTHS .016 TO .019 STRIP

PART NUMBER	ID	LENGTH
302-4020-12	4.00"	12"
302-4020-18	4.00"	18"
302-4020-24	4.00"	24"
302-4020-36	4.00"	36"
302-5020-12	5.00"	12"
302-5020-18	5.00"	18"
302-5020-24	5.00"	24"
302-5024-36	5.00"	36"

TUBING



ALUMINUM

DURABLE, RUST RESISTANT, LIGHT WEIGHT FOR AIR INLET TUBING. FURNISHED IN 10' SECTIONS.

STEEL

EXCELLENT SERVICE LIFE ALL TUBING MEETS SAE SPEC. 1006/1008. AVAILABLE IN 10' MILL LENGTHS, SIZES UP TO 6" ARE 16 GAUGE. 7", 8" & 10" ARE 14 GAUGE. 12" IS 12 GAUGE

ALUMINIZED

ALUMINUM COATED STEEL TUBING. USE IN PLACE OF STEEL TUBING WHEN SUPERIOR CORROSION RESISTANCE IS DESIRED. THIS TUBING CANNOT BE PLATED.

STAINLESS STEEL

304 STAINLESS STEEL. 16 AND 11 GAUGE.

STEEL TUBING

PART NO.	SIZE
10-15	1.50"
10-175	1.75"
10-20	2.00"
10-225	2.25"
10-25	2.50"
10-275	2.75"
10-30	3.00"
10-35	3.50"
10-40	4.00"
10-45	4.50"
10-50	5.00"
10-55	5.50"
10-60	6.00"
10-70	7.00"
10-80	8.00"
10-10	10.00"
10-12	12.00"

ALUMINIZED TUBING

PART NO.	SIZE
4310-20	2.00"
4310-25	2.50"
4310-30	3.00"
43610-35	3.50"
4310-40	4.00"
4310-50	5.00"
4310-60	6.00"

ALUMINUM TUBING

PART NO.	SIZE
27-030	3.00"
27-040	4.00"
27-050	5.00"
27-055	5.50"
27-060	6.00"
27-070	7.00"
27-080	8.00"

STAINLESS TUBING

PART NO.	SIZE
10-20-065-304 SS	2.00"
10-25-065-304 SS	2.50"
10-30-065-304 SS	3.00"
10-35-065-304 SS	3.50"
10-40-065-304 SS	4.00"
10-50-065-304 SS	5.00"
10-60-065-304 SS	6.00"
10-40-125-304 SS	4.00"
10-50-125-304 SS	5.00"

ELBOWS
STACKS
CONNECTORS

RAIN CAPS
& CLAMPS

GUARDS
& TUBING

AIR INTAKE
PARTS

PERFORMANCE
EXHAUST

HOOD HOOKS
& FENDERS

MUFFLERS

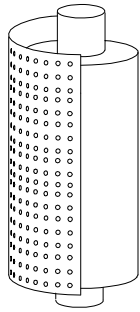

POLISHED STAINLESS STEEL MUFFLER GUARDS

180 DEG 1/2 CIRCLE

Part No.	Size	Description
57-9513-9	9"	MUFFLER GUARD ONLY
57-9513-10	10"	MUFFLER GUARD ONLY
57-9511-9	9"	MUFFLER GUARD WITH CLAMPS
57-9511-10	10"	MUFFLER GUARD WITH CLAMPS

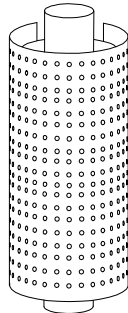

270 DEG 3/4 CIRCLE

Part No.	Size	Description
57-9713-9	9"	MUFFLER GUARD ONLY
57-9713-10	10"	MUFFLER GUARD ONLY
57-9711-9	9"	MUFFLER GUARD WITH CLAMPS
57-9711-10	10"	MUFFLER GUARD WITH CLAMPS

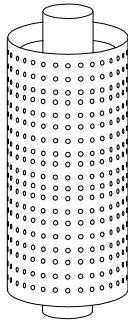

360 DEG FULL CIRCLE

Part No.	Size	Description
57-9913-9	9"	MUFFLER GUARD ONLY
57-9913-10	10"	MUFFLER GUARD ONLY
57-9911-9	9"	MUFFLER GUARD WITH CLAMPS
57-9911-10	10"	MUFFLER GUARD WITH CLAMPS

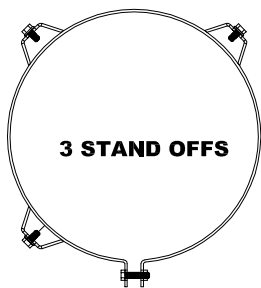

ZINC PLATED MUFFLER GUARD CLAMPS

Part No.	Size	Description
56-9515-9	9"	MUFFLER GUARD CLAMP 3 STAND OFFS
56-9515-9-4	9"	MUFFLER GUARD CLAMP 4 STAND OFFS
56-9515-10	10"	MUFFLER GUARD CLAMP 3 STAND OFFS
56-9515-10-4	10"	MUFFLER GUARD CLAMP 4 STAND OFFS

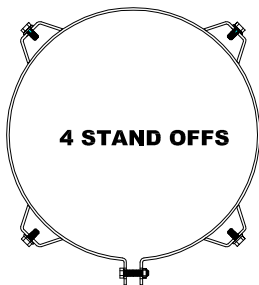

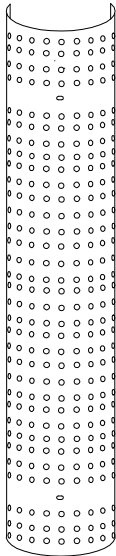
**POLISHED STAINLESS STEEL STACK GUARDS**

180 DEG 1/2 CIRCLE

Part No.	Size	Description
57-4480	4"	STACK GUARD ONLY
57-5480	5"	STACK GUARD ONLY
57-6480	6"	STACK GUARD ONLY
57-4482	4"	STACK GUARD WITH CLAMPS
57-5482	5"	STACK GUARD WITH CLAMPS
57-6482	6"	STACK GUARD WITH CLAMPS

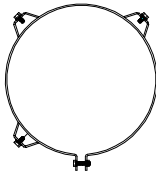
**3 STAND OFFS****ZINC PLATED STACK GUARD CLAMPS**

(CLAMPS SOLD INDIVIDUALLY)

Part No.	Size	Description
56-9514-4	4"	4" STACK GUARD CLAMP
56-9514-5	5"	5" STACK GUARD CLAMP
56-9514-6	6"	6" STACK GUARD CLAMP

CHROME PLATED GRAB HANDLES

Part No.	Description
56-9818	18" GRAB HANDLE
56-9824	24" GRAB HANDLE

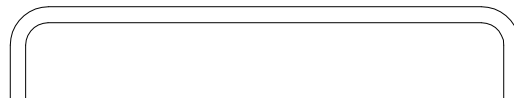

**PLEASE CONTACT US FOR QUOTES ON CUSTOM BENDING REQUIREMENTS
AVAILABLE IN ALUMINIZED, 304 STAINLESS STEEL AND COLD ROLLED STEEL**

ELBOWS
STACKS
CONNECTORS

RAIN CAPS
& CLAMPS

GUARDS
& TUBING

AIR INTAKE
PARTS

PERFORMANCE
EXHAUST

HOOD HOOKS
& FENDERS

MUFFLERS

90 DEG ELBOWS

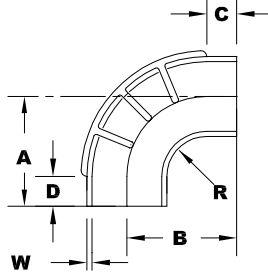

PART NUMBER	ID	A	B	C	D	R	W	CLAMP NUMBER
7-290	2.00	3.50	3.50	1.50	1.50	2.00	.22	8-20
7-22590	2.25	3.75	3.75	1.50	1.50	2.25	.22	8-225
7-2590	2.50	4.00	4.00	1.50	1.50	2.50	.25	8-25
7-390	3.00	5.25	5.25	1.75	1.50	2.00	.25	8-30
7-3590	3.50	5.50	5.50	1.75	1.50	2.00	.25	8-35
7-490	4.00	5.75	5.75	1.75	1.50	2.00	.25	8-40
7-4590	4.50	6.00	6.00	1.75	1.50	1.75	.25	8-45
7-590	5.00	6.12	6.12	1.75	1.62	1.75	.25	8-50
7-5590	5.50	6.50	6.50	1.75	1.75	1.75	.25	8-55
7-690	6.00	7.00	7.00	2.25	2.00	1.75	.25	8-60
7-790	7.00	7.56	7.56	2.25	2.00	1.75	.31	8-70
7-890	8.00	8.50	8.50	2.00	2.25	2.12	.37	8-80
7-1090	10.00	10.50	10.50	2.25	2.25	3.12	.37	8-91

ALL ELBOWS 5.5" AND OVER ARE RIBBED TO PROVIDE MAXIMUM RESISTANCE TO INTERNAL VACUUM

SHORT RADIUS 90 DEG ELBOWS

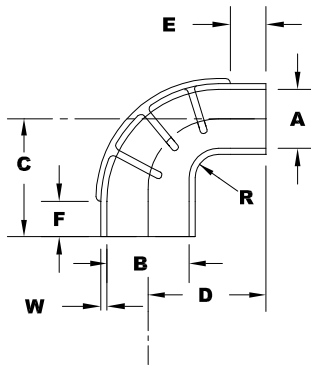

PART NUMBER	ID	A	B	C	D	R	W	CLAMP NUMBER
73-5590	5.50	6.50	6.50	1.75	1.75	1.75	.25	8-55
73-5591	5.50	8.00	6.00	1.75	1.75	1.00	.25	8-55
73-690	6.00	5.00	5.00	1.50	1.50	1.00	.25	8-60
73-691	6.00	5.00	6.50	1.50	1.50	1.00	.25	8-60

90 DEG REDUCING ELBOWS

PART NUMBER	A	B	C	D	E	F	R	W	CLAMP NUMBER
7-42590	2.50	4.00	6.50	6.50	—	—	—	—	8-275 / 8-40
7-427590	2.75	4.00	6.50	4.00	—	—	3.00	.25	8-275 / 8-40
7-43590	4.00	3.50	3.62	4.50	1.50	.500	3.00	.19	8-40 / 8-35
7-5490	4.00	5.00	5.75	6.00	—	—	3.75	.25	8-40 / 8-50
7-55590	5.50	5.00	6.50	5.20	1.20	2.50	4.00	.25	8-55 / 8-50
7-6590	5.00	6.00	7.00	6.00	1.50	1.70	1.50	.25	8-50 / 8-60
7-65590	5.50	6.00	6.75	6.75	1.75	1.75	1.75	.25	8-55 / 8-60
7-7590	5.00	7.00	7.00	6.25	1.75	2.75	1.50	.25	8-50 / 8-70
7-75590	5.50	7.00	5.75	6.25	1.50	1.50	.625	.31	8-55 / 8-70
7-7690	6.00	7.00	9.00	7.56	3.00	3.00	.500	.37	8-60 / 8-70
7-8790	7.00	8.00	8.00	8.00	2.00	2.00	4.00	.50	8-70 / 8-80

90 DEG SHORT RADIUS REDUCING ELBOWS

PART NUMBER	A	B	C	D	E	F	R	W	CLAMP NUMBER
73-6590	5.00	6.00	4.75	4.75	1.25	1.25	1.25	.25	8-50 / 8-60
73-65590	5.50	6.00	4.80	5.00	1.50	1.50	1.50	.25	8-55 / 8-60

45 DEGREE ELBOWS

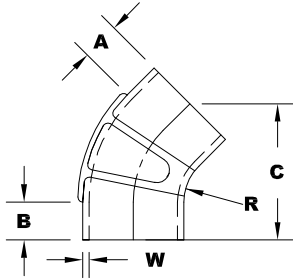

PART NUMBER	ID	A	B	C	R	W	CLAMP NUMBER
7-2245	2.25	3.00	1.12	—	1.54	.16	8-225
7-345	3.00	1.50	1.50	5.50	2.00	.25	8-30
7-3545	3.50	1.50	1.50	5.50	2.00	.25	8-35
7-445	4.00	1.50	1.50	5.50	2.00	.25	8-40
7-545	5.00	1.62	1.62	5.25	1.75	.25	8-50
7-5545	5.50	1.75	1.75	6.25	1.75	.25	8-55
7-645	6.00	2.00	2.00	6.50	1.75	.25	8-60
7-745	7.00	2.25	2.25	8.00	1.75	.31	8-70
7-845	8.00	2.25	2.25	8.25	2.12	.37	8-80
7-1045	10.00	2.25	2.25	10.50	3.12	.37	8-91

ALL ELBOWS 5.5" AND OVER ARE RIBBED TO PROVIDE MAXIMUM RESISTANCE TO INTERNAL VACUUM

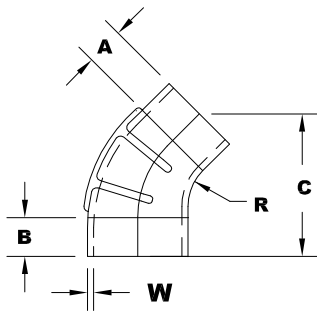

45 DEGREE REDUCING ELBOWS

PART NUMBER	ID	A	B	C	R	W	CLAMP NUMBER
7-65545	5.50 X 6.00	1.75	1.75	6.50	4.87	.25	8-55 / 8-60
7-645	6.00 X 7.00	2.00	2.00	7.38	5.56	.31	8-60 / 8-70

SPECIAL APPLICATION ELBOWS

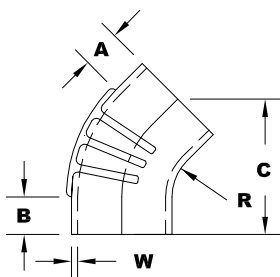

PART NUMBER	DEG	ID	A	B	C	R	W	CLAMP NUMBER
7-422	22	4.00	1.50	1.50	4.50	1.75	.25	8-40
7-4568	68	4.50	1.50	1.50	6.75	1.75	.25	8-45
7-5522	22	5.50	1.75	1.75	5.25	1.75	.25	8-55
7-5554	54	5.50	1.75	1.75	7.75	2.50	.25	8-55
7-5568	68	5.50	1.75	1.75	8.25	4.00	.25	8-55
7-622	22	6.00	1.75	1.75	5.25	1.75	.25	8-60
7-638	38	6.00	2.30	2.30	7.25	.750	.31	8-60
7-654	54	6.00	1.50	1.50	7.50	2.50	.25	8-60
7-668	68	6.00	1.75	1.75	8.50	4.00	.25	8-60
7-722	22	7.00	1.75	1.75	5.49	5.56	.31	8-70
7-768	68	7.00	2.00	2.00	7.93	5.56	.31	8-70
7-7668	68	7.00 X 6.00	2.00	2.00	7.93	5.56	.31	8-70
7-863	63	8.00	2.00	2.00	11.00	1.25	.37	8-80

ELBOWS
STACKS
CONNECTORS

RAIN CAPS
& CLAMPS

GUARDS
& TUBING

AIR INTAKE
PARTS

PERFORMANCE
EXHAUST

HOOD HOOKS
& FENDERS

MUFFLERS

HUMP HOSE

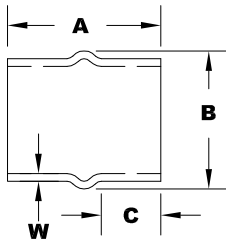

PART NUMBER	ID	A	B	C	W	CLAMP NUMBER
7-830	3.00	5.25	4.50	2.00	2.00	8-30
7-835	3.50	5.25	5.00	2.00	.25	8-35
7-840	4.00	5.25	5.37	2.00	.25	8-40
7-844	4.50	6.00	6.00	3.00	.25	8-45
7-850	5.00	6.00	6.12	2.25	.25	8-50
7-855	5.50	6.00	7.00	2.25	.25	8.55
7-860	6.00	6.00	7-38	3.00	.25	8-60
7-870	7.00	7.00	8-50	2.50	.31	8-70
7-880	8.00	8.00	10.37	3.00	.31	8-81
7-810	10.00	6.00	11.50	2.00	.25	8-91

HUMP HOSE REDUCERS

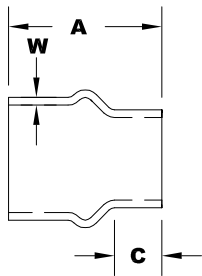

PART NUMBER	ID	A	B	C	D	W	CLAMP NUMBER
7-325	2.50 X 3.00	6.00	4.25	2.12	3.00	.25	8-275 / 8-30
7-353	3.00 X 3.50	5.25	5.00	2.12	2.12	.25	8-30 / 8-35
7-4275	2.75 X 4.00	4.00	5.50	.750	2.25	.19	8-275 / 8-40
7-430	3.00 X 4.00	5.25	5.50	1.50	1.75	.25	8-30 / 8-40
7-435	3.50 X 4.00	5.00	5.38	1.75	2.50	.21	8-35 / 8-40
7-540	4.00 X 5.00	5.50	6.50	1.50	1.75	.25	8-40 / 8-50
7-554	4.00 X 5.50	6.00	7.00	1.87	2.00	.25	8-40 / 8-55
7-555	5.00 X 5.50	6.00	7.00	1.87	2.00	.25	8-50 / 8-55
7-650	5.00 X 6.00	6.00	7.50	1.87	2.00	.25	8-50 / 8-60
7-655	5.50 X 6.00	6.00	7.50	2.00	2.00	.25	8-55 / 8-60
7-750	5.00 X 7.00	7.00	8.50	2.25	3.50	.25	8-50 / 5-70
7-755	5.50 X 7.00	7.00	8.50	2.25	2.75	.25	8-55 / 8-70
7-760	6.00 X 7.00	5.00	8.50	1.44	1.50	.25	8-60 / 8-70
7-558	5.50 X 8.00	7.00	9.50	1.75	1.75	.25	8-55 / 8-81
7-680	6.00 X 8.00	5.00	9.50	1.38	1.50	.25	8-60 / 8-81
7-780	7.00 X 8.00	5.00	9.50	1.44	1.50	.25	8-70 / 8-81
7-108	8.00 X 10.00	6.00	11.50	1.75	2.00	.25	8-81 / 8-91

REDUCER INLET SLEEVE

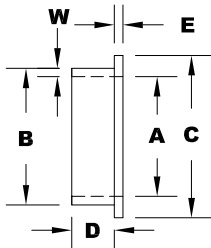

PART NUMBER	A	B	C	D	E	W
7-423	3.00	4.00	4.50	1.25	.25	.50
7-4235	3.50	4.00	4.50	1.25	.25	.25
7-4524	4.00	4.50	5.00	1.50	.25	.25
7-524	4.00	5.00	5.50	1.50	.25	.50
7-5524	4.00	5.50	6.00	1.50	.25	.25
7-5245	4.50	5.00	5.50	1.50	.25	.25
7-5525	5.00	5.50	6.00	1.50	.25	.25
7-625	5.00	6.00	6.50	1.50	.25	.25
7-6255	5.50	6.00	6.50	1.50	.25	.25
7-726	6.00	7.00	7.50	1.50	.25	.50
7-827	7.00	8.00	8-50	1.50	.25	.50

AIR INLET CLAMPS

PART NUMBER	MIN DIA.	MAX DIA.
8-20	2.03"	2.34"
8-225	2.40"	2.71"
8-25	2.53"	2.84"
8-275	3.03"	3.34"
8-30	3.28"	3.59"
8-325	3.53"	3.84"
8-35	3.78"	4.09"
8-40	4.28"	4.59"
8-45	4.78"	5.09"
8-50	5.28"	5.59"
8-525	5.50"	6.15"
8-55	5.81"	6.46"
8-60	6.40"	7.05"
8-70	7.25"	7.90"
8-80	8.56"	9.22"
8-81	8.16"	8.81"
8-91	10.50"	11.15"

PERMITS FLEXIBLE ASSEMBLY OF
RUBBER ELBOWS AND ALUMINUM
TUBING. FULL CLAMPING ACTION.
STAINLESS STEEL BAND WITH EXTRA
LONG 2.75" T-BOLT

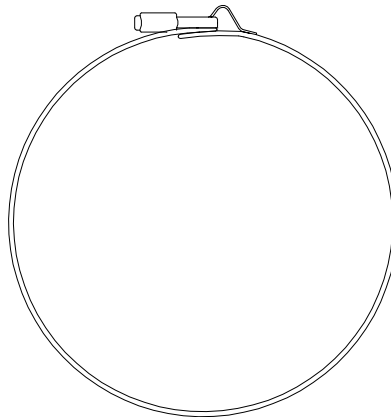

ELBOWS
STACKS
CONNECTORS

RAIN CAPS
& CLAMPS

GUARDS
& TUBING

AIR INTAKE
PARTS

PERFORMANCE
EXHAUST

HOOD HOOKS
& FENDERS

MUFFLERS

ALL PERFORMANCE RETROFIT SYSTEMS INCLUDE

4" DIAMETER MANDREL BEND PIPES
LESS BACK PRESSURE
EASE OF INSTALLATION

16 GA ALUMINIZED STEEL
IMPROVED PERFORMANCE
ONE PIECE TAIL PIPE CONSTRUCTION

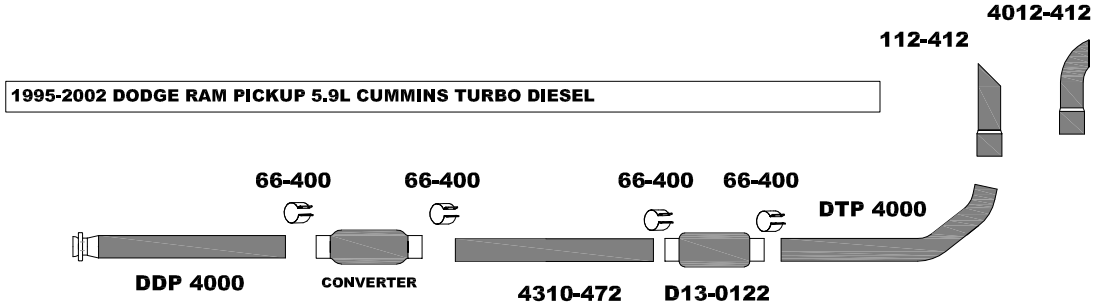
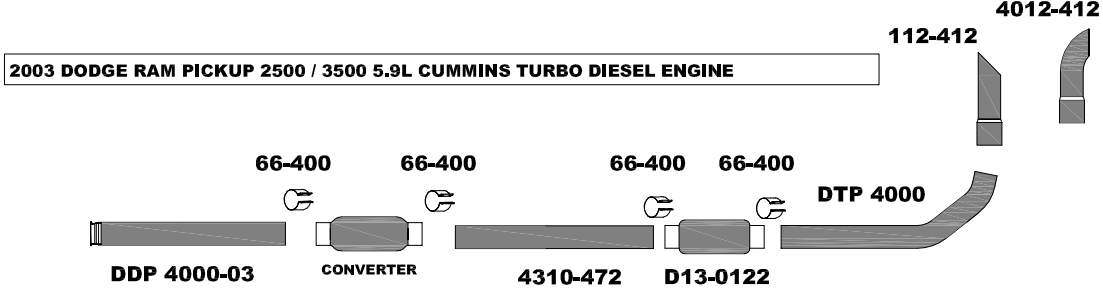
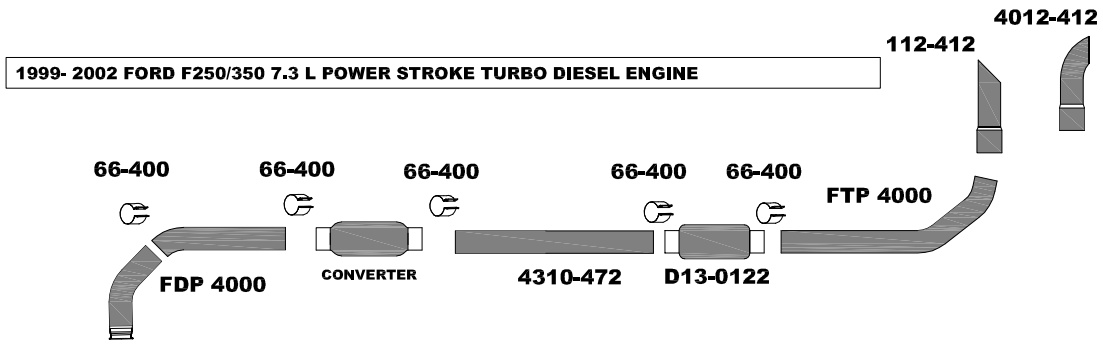
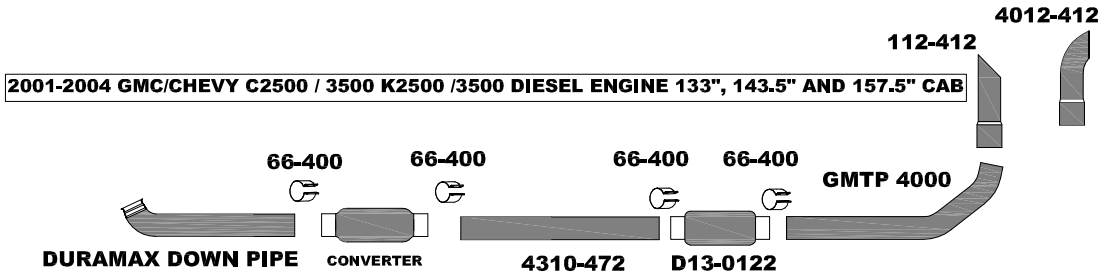

PLEASE CONTACT US FOR QUOTES ON CUSTOM BENDING REQUIREMENTS
AVAILABLE IN ALUMINIZED, 304 STAINLESS STEEL AND COLD ROLLED STEEL

Tiedown Hooks

Part Number	Description (length x width)
36-350	3 1/2" x 1.9"
36-500	5 1/16" x 3 1/2"
36-501*	5 1/16" x 3 1/2"
36-575	5 7/8" x 3 1/2"
36-576*	5 7/8" x 3 1/2"
36-800*	8" x 3 1/2"
36-1300	13" x 3 1/2"

* Has anti-rattle nub.

Anchor Pins

Part Number	Description (length x width)
36-015	1 5/8" Anchor Bracket
36-017	1 1/4" Anchor Bracket

Hood Hook & Battery Box Latch Kits

Part Number	Description	Contents
36-350K	5 1/16" x 3 1/2" Tiedown/Battery Box Hook Kit	1) 36-350 – 3 1/2" x 1.9" Tiedown Strap 1) 36-017 – 1 1/2" Anchor Bracket 1) 36-006 – 1 1/8" Long Hood Bracket, Stem Up 1) 36-013 – 1/4" NC x 1 1/2" HH N/Lock Nut
36-500K	5 1/16" x 3 1/2" Tiedown/Battery Box Hook Kit	1) 36-500 – 5 1/16" x 3 1/2" Tiedown Strap 1) 36-017 – 1 1/2" Anchor Bracket 1) 36-006 – 1 1/8" Long Hood Bracket, Stem Up 1) 36-013 – 1/4" NC x 1 1/2" HH N/Lock Nut
36-501K	5 1/16" x 3 1/2" Tiedown/Battery Box Hook Kit	1) 36-501 – 5 1/16" x 3 1/2" Tiedown Strap (Has anti-rattle nub) 1) 36-017 – 1 1/2" Anchor Bracket 1) 36-004 – 2 5/32" Long Hood Bracket, Stem Up 1) 36-013 – 1/4" NC x 1 1/2" HH N/Lock Nut
36-575K	5 7/8" x 3 1/2" Tiedown/Battery Box Hook Kit	1) 36-575 – 5 7/8" x 3 1/2" Tiedown Strap 1) 36-015 – 1 5/8" Anchor Bolt 1) 36-012 – 5/16" NF x 2" HH N/Lock Nut 1) 36-006 – 1 1/8" Long Hood Bracket, Stem Up
36-576K	5 1/16" x 3 1/2" Tiedown/Battery Box Hook Kit	1) 36-576 – 5 7/8" x 3 1/2" Tiedown Strap (has anti-rattle nub) 1) 36-015 – 1 5/8" Anchor Bolt 1) 36-012 – 5/16" NF x 2" HH N/Lock Nut 1) 36-002 – 2 1/16" Long Hood Bracket, Stem Down <i>Interchanges with Peterbilt Part No. 23-02233</i>
36-800K	8" x 3 1/2" Tiedown Hood Hook Kit	1) 36-800 – 8" x 3 1/2" Tiedown Strap 1) 36-015 – 1 5/8" Anchor Bolt 1) 36-004 – 2 5/32" Long Hood Bracket, Stem Up 1) 36-012 – 5/16" NF x 2" HH N/Lock-Nut <i>Interchanges with Peterbilt Part No 23-02700 and Freightliner Part No. N31-01073-00</i>
36-1300K	13" x 3 1/2" Tiedown Hood Hook Kit	1) 36-1300 – 13" x 3 1/2" Tiedown Strap 1) 36-015 – 1 5/8" Anchor Bolt 1) 36-004 – 2 5/32" Long Hood Bracket, Stem Up 1) 36-012 – 5/16" NF x 2" HH N/Lock-Nut

Hood Brackets

Part Number	Description (length x width)
36-001	Stem Up Bracket, 1 1/8" Long
36-002	Stem Down Bracket, 2 1/16" Long
36-003	Stem Down with Slot, 2 1/16" Long
36-004	Stem Up, 2 5/32" Long
36-005	Stem Flat, 3 1/4" Long
36-006	Stem Up, 1 1/8" Long

Bolts & Nuts/Hardware

Part Number	Description (length x width)
36-012	5/16" NF x 2" HH N/Lock-Nut
36-013	1/4" NC x 1 1/2" HH N/Lock-Nut

ELBOWS
STACKS
CONNECTORS

RAIN CAPS
& CLAMPS

GUARDS
& TUBING

AIR INTAKE
PARTS

PERFORMANCE
EXHAUST

HOOD HOOKS
& FENDERS

MUFFLERS

Rubber Hooks

Determine stretch or holding force required from the load deflection chart. Add zero-stretch dimension (A or B) to locate hood bracket in relation to anchor bracket.

Load Deflection Chart

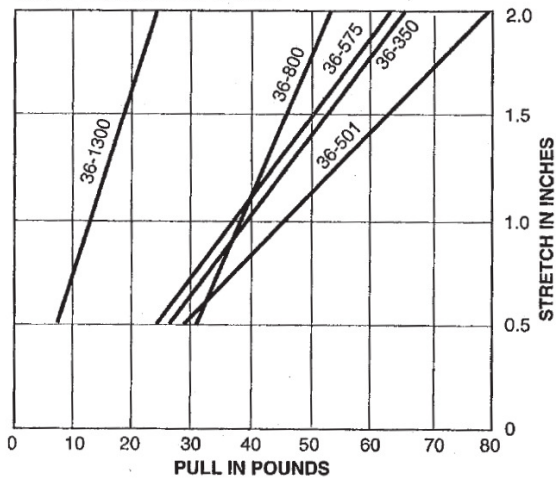

Zero Stretch Dimensions

Hood Hook	36-002	36-001	36-004	36-006
36-350	A = 1 1/16	B = 2 3/8	B = 2 3/8	B = 4 13/16
36-500	A = 2	B = 3 3/16	B = 3 3/16	B = 6
36-501	A = 2	B = 3 3/16	B = 3 3/16	B = 6
36-575	A = 2 5/8	B = 3 7/8	B = 3 7/8	B = 6 11/16
36-576	A = 2 5/8	B = 3 7/8	B = 3 7/8	B = 6 11/16
36-800	A = 4 3/4	B = 6 1/16	B = 6 1/16	B = 8 5/8
36-1300	A = 10 5/8	B = 11 3/4	B = 11 3/4	B = 14 19/32

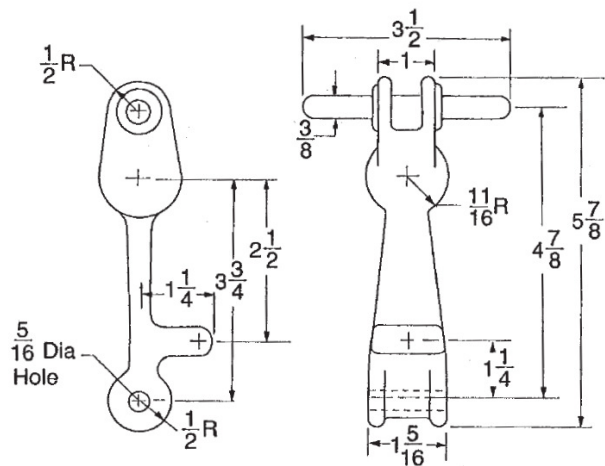
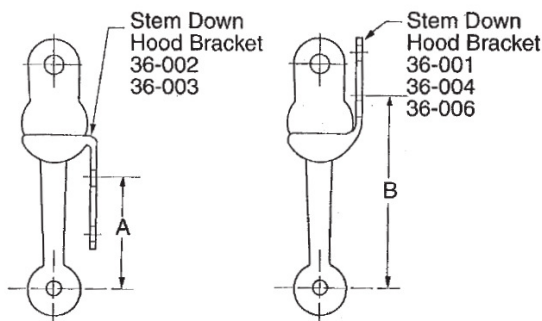

Stock No. 36-576, with anti-rattle nub. Our standard model. Especially suited to fasten truck hoods and heavy duty applications

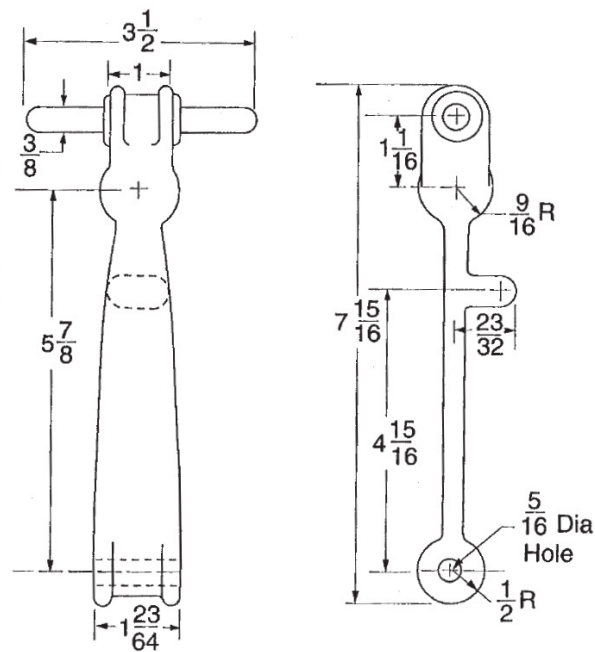

Stock No. 36-800, with anti-rattle nub.

Metal Hardware

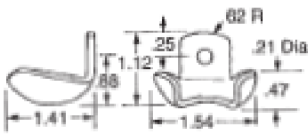

Hood Bracket
Stock No. 36-001
Short stem-up type,
12 gauge zinc-plated
steel. Use with
all hooks.

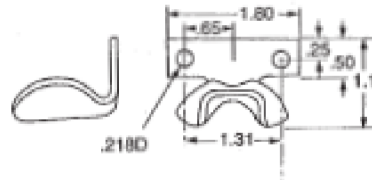

Hood Bracket
Stock No. 36-006
Short stem-up type,
13 gauge zinc-plated
steel. Use with
all hooks.

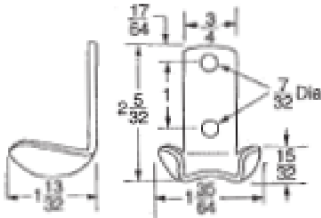

Hood Bracket
Stock No. 36-004
Stem-up type,
12 gauge zinc-plated
steel. Use with
all hooks.

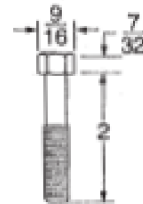

Anchor Bolts
Stock No. 36-012
5/16 NF x 2 HH
Cad. Pl. Bolt
W/Self-Locking Nut.
Use with Nos.
36-576, 36-575, 36-800
and 36-1300.

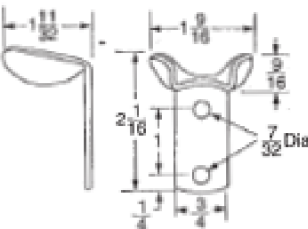

Hood Bracket
Stock No. 36-002
Stem-down type,
12 gauge zinc-plated
steel. Use with
all hooks.

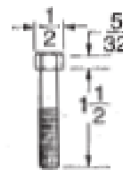

Anchor Bolts
Stock No. 36-013
1/4 NC x 1 1/2" HH
Cad. Pl. Bolt
W/Self-Locking Nut.
Use with Nos.
36-501, 36-500,
and 36-350.

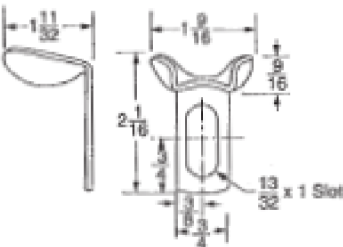

Hood Bracket
Stock No. 36-003
Stem-down type with
slot, Zinc-plated
12-gauge steel.
Use with all hooks.

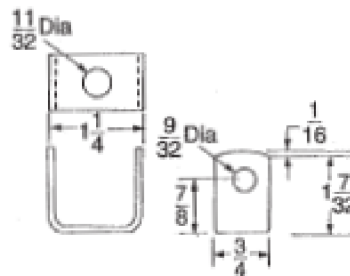

Anchor Bracket
Stock No. 36-017
11 gauge zinc-plated
steel. Use with Nos.
36-576, 36-575, 36-
800 and 36-1300.

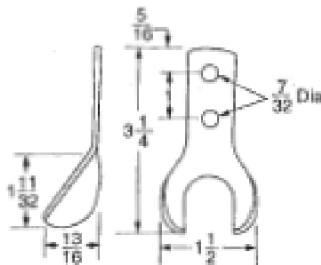

Hood Bracket
Stock No. 36-005
Stem-flat type,
12 gauge zinc-plated
steel. Use with
all hooks.

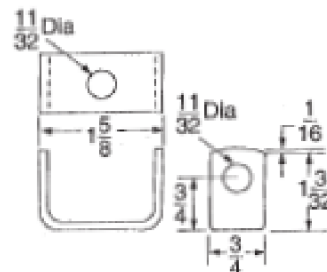

Anchor Bracket
Stock No. 36-015
14 gauge zinc-plated
steel. Use with Nos.
36-501, and 36-350.

ELBOWS
STACKS
CONNECTORS

RAIN CAPS
& CLAMPS

GUARDS
& TUBING

AIR INTAKE
PARTS

PERFORMANCE
EXHAUST

HOOD HOOKS
& FENDERS

MUFFLERS

Metal Hardware

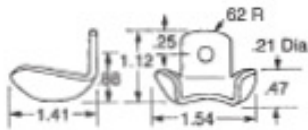

Hood Bracket
Stock No. 36-001
Short stem-up type,
12 gauge zinc-plated
steel. Use with
all hooks.

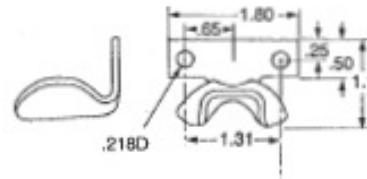

Hood Bracket
Stock No. 36-006
Short stem-up type,
13 gauge zinc-plated
steel. Use with
all hooks.

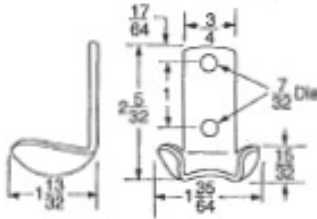

Hood Bracket
Stock No. 36-004
Stem-up type,
12 gauge zinc-plated
steel. Use with
all hooks.

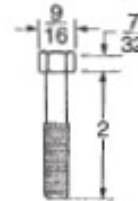

Anchor Bolts
Stock No. 36-012
5/16 NF x 2 HH
Cad. Pl. Bolt
W/Self-Locking Nut.
Use with Nos.
36-576, 36-575, 36-800
and 36-1300.

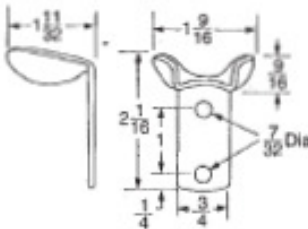

Hood Bracket
Stock No. 36-002
Stem-down type,
12 gauge zinc-plated
steel. Use with
all hooks.

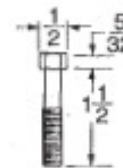

Anchor Bolts
Stock No. 36-013
1/4 NC x 1 1/2" HH
Cad. Pl. Bolt
W/Self-Locking Nut.
Use with Nos.
36-501, 36-500,
and 36-350.

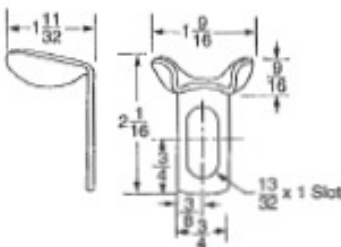

Hood Bracket
Stock No. 36-003
Stem-down type with
slot, Zinc-plated
12-gauge steel.
Use with all hooks.

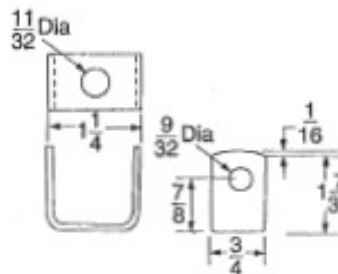

Anchor Bracket
Stock No. 36-017
11 gauge zinc-plated
steel. Use with Nos.
36-576, 36-575, 36-
800 and 36-1300.

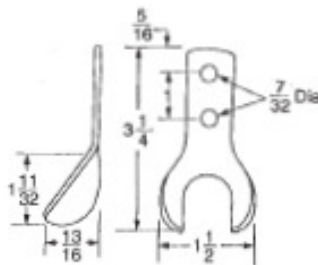

Hood Bracket
Stock No. 36-005
Stem-flat type,
12 gauge zinc-plated
steel. Use with
all hooks.

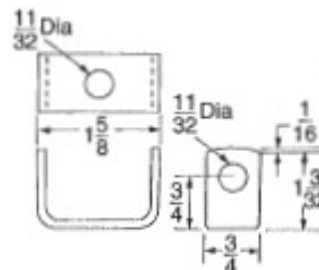

Anchor Bracket
Stock No. 36-015
14 gauge zinc-plated
steel. Use with Nos.
36-501, and 36-350.

TYPE 1 CENTER END INLET / END OUTLET

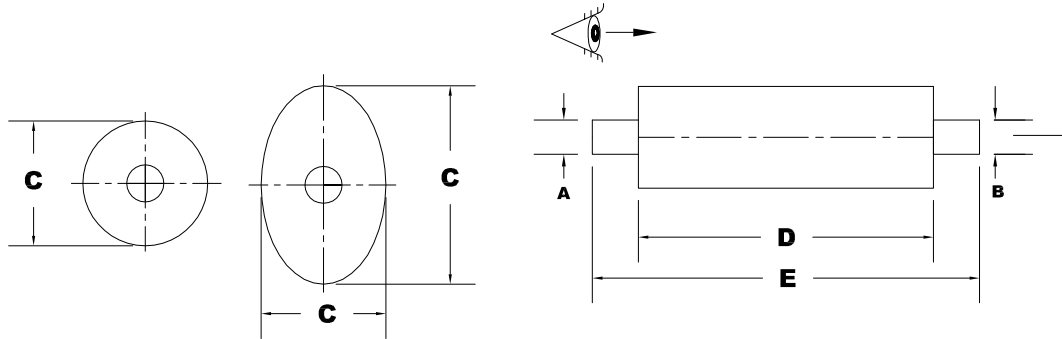
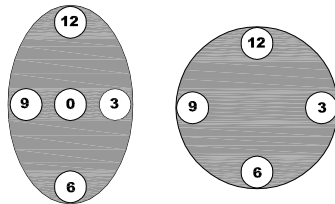
INLET-OUTLET CLOCK POSITIONS

OVAL MUFFLER
ROUND MUFFLER

NOTE: ALL CLOCK POSITIONS ARE DETERMINED BY VIEWING THE MUFFLER FROM THE END VIEW, NEAREST THE INLET.

PART NUMBER	A INLET SIZE	B OUTLET SIZE	C BODY SIZE	D BODY LENGTH	E OVERALL LENGTH	F INLET OFFSET	G OUTLET OFFSET	H INLET LENGTH	INLET CLOCK POSITION	OUTLET CLOCK POSITION
D13-0087	2.50	2.25	8.00	22.00	28.00	0.00	0.00	3.00	0.00	0.00
D12-4000	2.50	2.50	6.00	26.50	32.00	0.00	0.00	2.75	0.00	0.00
D13-7601	2.50	2.50	6.00	22.00	29.50	0.00	0.00	3.75	0.00	0.00
Q-198-12	2.50	2.50	6.50	17.00	23.00	0.00	0.00	3.00	0.00	0.00
D13-7594	3.00	3.00	7.00	15.00	20.00	0.00	0.00	2.50	0.00	0.00
D13-7593	3.00	3.00	7.00	15.00	20.00	0.00	0.00	2.50	0.00	0.00
D13-7602	3.00	3.00	6.00	21.00	30.00	0.00	0.00	4.50	0.00	0.00
D99-0215	3.00	3.00	9.00	11.50	16.00	0.00	0.00	2.25	0.00	0.00
D13-7635	3.00	3.00	9.00	10.00	16.00	0.00	0.00	3.00	0.00	0.00
D99-0093	3.00	3.00	10.00	23.00	30.00	0.00	0.00	3.50	0.00	0.00
D12-4005	3.00	3.00	7.00	26.50	32.50	0.00	0.00	3.00	0.00	0.00
D12-4006	3.00	3.00	7.00	22.00	28.00	0.00	0.00	3.00	0.00	0.00
D13-0053	3.00	3.00	9.00	23.00	35.00	0.00	0.00	9.00	0.00	0.00
D99-0181	3.00	3.00	6.00	26.50	33.50	0.00	0.00	3.50	0.00	0.00
Q-077-11	3.00	3.00	6.00	12.00	31.93	0.00	0.00	10.82	0.00	0.00
D14-0289	3.00	3.13	8.00	12.00	17.00	0.00	0.00	2.50	0.00	0.00
D13-3590	3.50	3.50	9.00	44.00	51.00	0.00	0.00	3.50	0.00	0.00
D13-7595	3.50	3.50	7.00	15.00	20.00	0.00	0.00	2.50	0.00	0.00
D13-3500	3.50	3.50	8.50	29.50	37.00	0.00	0.00	3.75	0.00	0.00
D13-0110	3.50	4.00	8.50	29.50	36.00	0.00	0.00	3.25	0.00	0.00
D13-4590	4.00	4.00	9.00	44.00	51.00	0.00	0.00	3.50	0.00	0.00
D13-4060	4.00	4.00	8.50	33.00	40.00	0.00	0.00	3.50	0.00	0.00
D99-0291	4.00	4.00	8.50	30.00	37.00	0.00	0.00	3.50	0.00	0.00
D99-0270	4.00	4.00	9.00	44.00	51.50	0.00	0.00	3.75	0.00	0.00

ADDITIONAL MUFFLERS AVAILABLE ON SPECIAL ORDER TO ADDRESS CUSTOM APPLICATIONS

ELBOWS
STACKS

RAIN CAPS
& CLAMPS

GUARDS
& TUBING

AIR INTAKE
PARTS

PERFORMANCE
EXHAUST

HOOD HOOKS
& FENDERS

MUFFLERS

TYPE 1 CENTER END INLET / END OUTLET

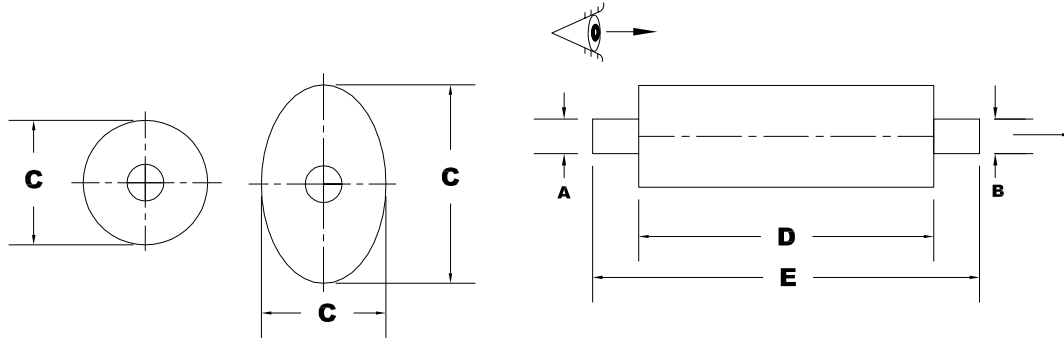

NOTE: ALL CLOCK POSITIONS ARE DETERMINED BY VIEWING THE MUFFLER FROM THE END VIEW, NEAREST THE INLET.

INLET-OUTLET CLOCK POSITIONS

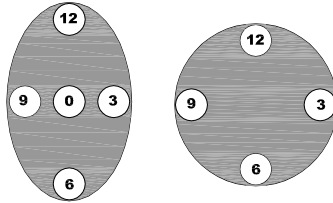

OVAL MUFFLER ROUND MUFFLER

PART NUMBER	A INLET SIZE	B OUTLET SIZE	C BODY SIZE	D BODY LENGTH	E OVERALL LENGTH	F INLET OFFSET	G OUTLET OFFSET	H INLET LENGTH	INLET CLOCK POSITION	OUTLET CLOCK POSITION
D13-2003	4.00	4.00	9.00	44.00	51.00	0.00	0.00	4.00	0.00	0.00
D13-2032	4.00	4.00	8.50	20.00	26.00	0.00	0.00	3.00	0.00	0.00
D13-4510	4.00	4.00	10.00	44.00	51.00	0.00	0.00	3.50	0.00	0.00
D13-7637	4.00	4.00	9.00	20.00	26.00	0.00	0.00	3.00	0.00	0.00
D13-0196	4.00	4.00	9.00	44.00	51.00	0.00	0.00	3.50	0.00	0.00
D13-1188	4.00	4.00	7.00	22.00	28.38	0.00	0.00	3.19	0.00	0.00
D14-0533	4.00	4.00	9.00	24.00	34.00	0.00	0.00	5.50	0.00	0.00
D99-0143	4.00	4.00	7.00	38.00	44.00	0.00	0.00	3.50	0.00	0.00
D99-0087	4.00	4.00	11.00	36.00	43.00	0.00	0.00	3.50	0.00	0.00
D13-0045	4.00	4.00	11.00	30.00	37.00	0.00	0.00	3.50	0.00	0.00
D13-0079	4.00	4.00	10.00	36.00	43.00	0.00	0.00	3.50	0.00	0.00
D13-0122	4.00	4.00	8.50	24.00	31.00	0.00	0.00	3.50	0.00	0.00
D13-4525	4.00	4.00	10.00	34.00	41.50	0.00	0.00	3.75	0.00	0.00
D99-0129	4.00	4.00	10.00	34.00	41.50	0.00	0.00	3.75	0.00	0.00
D99-0208	4.00	5.00	10.00	44.00	51.50	0.00	0.00	3.75	0.00	0.00
D13-4095	4.00	5.00	9.00	44.00	51.50	0.00	0.00	3.75	0.00	0.00
D13-4515	4.00	5.00	10.00	44.00	51.50	0.00	0.00	3.75	0.00	0.00
D13-4015	4.00	5.00	10.00	44.00	51.50	0.00	0.00	3.75	0.00	0.00
D99-0271	4.00	5.00	10.00	44.00	51.50	0.00	0.00	3.75	0.00	0.00
D13-4595	4.00	5.00	9.00	44.00	51.50	0.00	0.00	3.75	0.00	0.00
Q-339-11	5.00	5.00	9.00	20.00	26.50	0.00	0.00	3.25	0.00	0.00
D13-0123	5.00	5.00	9.00	23.00	30.00	0.00	0.00	3.50	0.00	0.00
D13-5090	5.00	5.00	9.00	44.00	51.00	0.00	0.00	3.50	0.00	0.00
D13-5010	5.00	5.00	10.00	44.00	51.00	0.00	0.00	3.50	0.00	0.00

ADDITIONAL MUFFLERS AVAILABLE ON SPECIAL ORDER TO ADDRESS CUSTOM APPLICATIONS

TYPE 1 CENTER END INLET / END OUTLET

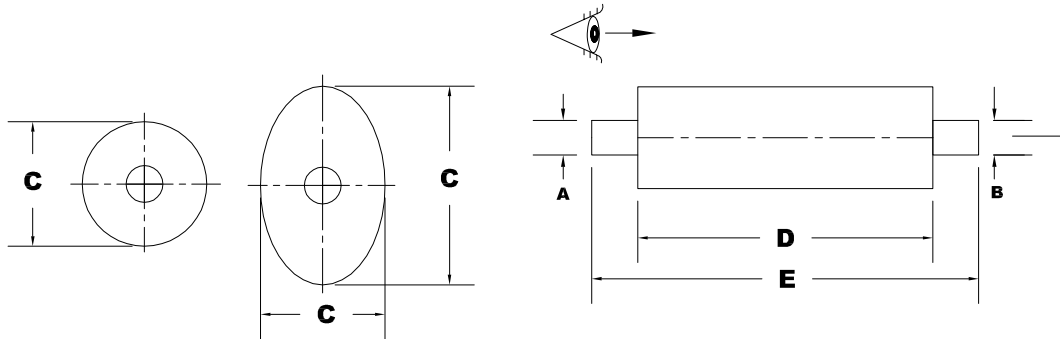

INLET-OUTLET CLOCK POSITIONS

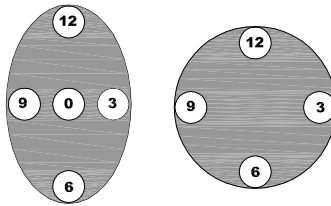

OVAL MUFFLER

ROUND MUFFLER

NOTE: ALL CLOCK POSITIONS ARE DETERMINED BY VIEWING THE MUFFLER FROM THE END VIEW, NEAREST THE INLET.

PART NUMBER	A INLET SIZE	B OUTLET SIZE	C BODY SIZE	D BODY LENGTH	E OVERALL LENGTH	F INLET OFFSET	G OUTLET OFFSET	H INLET LENGTH	INLET CLOCK POSITION	OUTLET CLOCK POSITION
D99-0272	5.00	5.00	9.00	44.00	51.50	0.00	0.00	3.75	0.00	0.00
D13-5511	5.00	5.00	10.00	44.00	51.00	0.00	0.00	3.50	0.00	0.00
D13-5510	5.00	5.00	10.00	44.00	51.00	0.00	0.00	3.50	0.00	0.00
D13-5520	5.00	5.00	10.00	58.00	66.00	0.00	0.00	4.00	0.00	0.00
D13-0099	5.00	5.00	10.00	44.00	51.50	0.00	0.00	3.75	0.00	0.00
D13-7650	5.00	5.00	9.00	33.00	40.00	0.00	0.00	3.50	0.00	0.00
D13-1157	5.00	5.00	11.00	51.00	57.00	0.00	0.00	3.00	0.00	0.00
D99-0301	5.00	5.00	11.00	55.00	61.00	0.00	0.00	3.00	0.00	0.00
Q-044-09	5.00	5.00	11.00	55.50	62.50	0.00	0.00	2.50	0.00	0.00
D16-0006	5.00	5.00	11.00	55.00	61.00	0.00	0.00	3.00	0.00	0.00
Q-126-12	5.00	5.00	13.00	45.25	50.75	0.00	0.00	2.75	0.00	0.00
Q-124-12	5.00	5.00	13.00	44.00	51.00	0.00	0.00	3.50	0.00	0.00
D13-0123SP	5.00	5.00	9.00	23.00	30.00	0.00	0.00	3.50	0.00	0.00
D13-1051	5.00	5.00	6.00	16.00	24.00	0.00	0.00	4.00	0.00	0.00
D13-5011	5.00	5.00	10.00	44.00	51.00	0.00	0.00	3.50	0.00	0.00
D99-0084	5.00	5.00	10.00	44.00	51.00	0.00	0.00	3.50	0.00	0.00
Q-050-12	5.00	5.00	14.00	35.75	40.75	0.00	0.00	2.50	0.00	0.00
Q-184-12	5.00	5.00	10.00	44.00	51.00	0.00	0.00	3.50	0.00	0.00
Q-215-11	5.00	5.00	8.00	55.00	62.00	0.00	0.00	3.50	0.00	0.00
Q-294-11	5.00	5.00	10.00	44.00	51.00	0.00	0.00	3.50	0.00	0.00
S13-0099	5.00	5.00	10.00	44.00	51.50	0.00	0.00	3.75	0.00	0.00
D13-1044	6.00	6.00	10.00	44.00	51.00	0.00	0.00	3.50	0.00	0.00
D14-0209	6.00	6.00	10.00	44.00	51.00	0.00	0.00	3.50	0.00	0.00

ADDITIONAL MUFFLERS AVAILABLE ON SPECIAL ORDER TO ADDRESS CUSTOM APPLICATIONS

ELBOWS
STACKS

RAIN CAPS
& CLAMPS

GUARDS
& TUBING

AIR INTAKE
PARTS

PERFORMANCE
EXHAUST

HOOD HOOKS
& FENDERS

MUFFLERS

ELBOWS
STACKS

RAIN CAPS
& CLAMPS

GUARDS
& TUBING

AIR INTAKE
PARTS

PERFORMANCE
EXHAUST

HOOD HOOKS
& FENDERS

MUFFLERS

TYPE 2 END INLET / END OUTLET

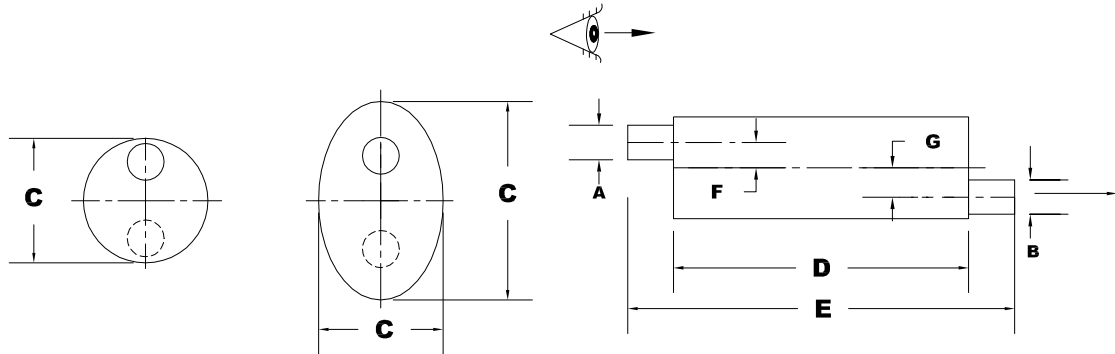

NOTE: ALL CLOCK POSITIONS ARE DETERMINED BY VIEWING THE MUFFLER FROM THE END VIEW, NEAREST THE INLET.

INLET-OUTLET CLOCK POSITIONS

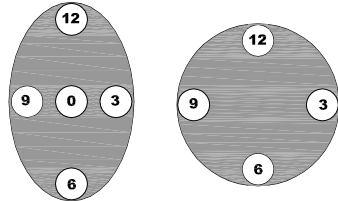

OVAL MUFFLER ROUND MUFFLER

PART NUMBER	A INLET SIZE	B OUTLET SIZE	C BODY SIZE	D BODY LENGTH	E OVERALL LENGTH	F INLET OFFSET	G OUTLET OFFSET	H INLET LENGTH	INLET CLOCK POSITION	OUTLET CLOCK POSITION
D12-2220	2.00	2.00	6.00	26.50	32.00	1.50	1.50	2.75	6.00	12.00
D11-5046	2.00	2.00	4x8	13.25	18.75	2.63	0.00	2.75	6.00	0.00
D11-5044	2.00	2.00	4x8	13.25	18.75	0.00	2.63	2.75	0.00	12.00
D12-2004	2.00	2.00	6.00	18.00	25.00	1.50	1.50	3.50	4.00	12.00
D12-5750	2.00	2.00	4x8	18.00	23.50	2.63	0.00	2.75	12.00	0.00
D12-2225	2.25	2.00	6.00	26.50	32.00	1.38	1.50	2.75	6.00	12.00
D12-2230	2.25	2.25	6.00	26.50	32.00	1.38	1.38	2.75	6.00	12.00
D12-2240	2.50	2.50	6.00	26.50	32.00	1.38	1.38	2.75	6.00	12.00
D12-2575	2.50	2.50	7.00	26.50	34.00	1.50	1.50	3.75	6.00	12.00
D99-0180	2.50	2.50	6.00	24.00	34.00	1.75	1.75	5.00	6.00	12.00
D12-2580	2.50	2.50	8.50	26.50	33.25	2.50	2.50	3.38	6.00	12.00
D99-0289	2.50	2.50	8.50	24.00	31.00	2.13	2.13	3.50	12.00	12.00
D99-0173	2.50	2.25	4x11	23.00	30.00	3.00	3.00	3.50	6.00	12.00
D12-2235	2.50	2.25	6.00	26.50	32.00	1.38	1.38	2.75	6.00	12.00
D12-2350	2.75	2.75	7.00	33.00	39.50	1.63	1.63	3.25	6.00	12.00
D12-3047	2.75	2.25	7.00	30.00	37.00	1.63	1.50	3.50	6.00	12.00
D99-0221	3.00	3.00	8.50	31.50	36.00	2.00	2.00	2.25	6.00	6.00
D12-3347	3.00	3.00	7.00	30.00	36.00	1.63	1.63	3.00	6.00	12.00
D12-3430	3.00	3.00	8.50	29.50	36.00	2.13	2.13	3.00	6.00	12.00
D12-3030	3.00	3.00	8.50	20.00	26.00	2.13	2.13	3.00	6.00	12.00
D13-4070	3.00	4.00	11.00	36.00	42.00	3.00	4.00	3.00	6.00	12.00
D11-5304	3.00	3.00	4x11	14.75	20.25	3.00	0.00	2.75	6.00	0.00
D12-5001	3.00	3.00	4x11	23.00	28.00	0.00	3.00	2.50	0.00	12.00
D12-5003	3.00	3.00	4x11	23.00	28.50	3.00	0.00	2.75	6.00	0.00
D99-0078	3.00	3.00	8.50	24.50	43.00	2.13	2.13	14.50	6.00	12.00
D99-0207	3.00	4.00	10.00	26.50	32.88	.5/2.23	1.5/2.23	3.38	11.00	6:30
D14-0835	3.50	2.50	8x11	20.00	25.00	3.25	3.25	2.50	12.00	6.00
D13-2002	3.50	3.50	8x11	26.50	33.00	3.00	3.00	3.25	6.00	12.00

TYPE 2 END INLET / END OUTLET

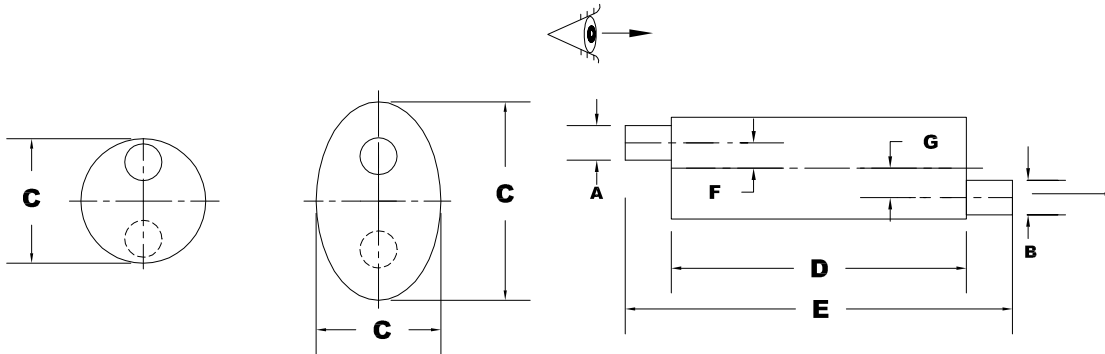
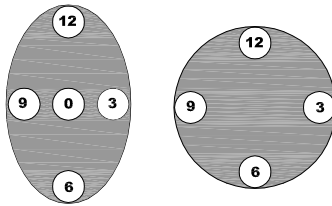
INLET-OUTLET CLOCK POSITIONS

OVAL MUFFLER
ROUND MUFFLER

NOTE: ALL CLOCK POSITIONS ARE DETERMINED BY VIEWING THE MUFFLER FROM THE END VIEW, NEAREST THE INLET.

PART NUMBER	A INLET SIZE	B OUTLET SIZE	C BODY SIZE	D BODY LENGTH	E OVERALL LENGTH	F INLET OFFSET	G OUTLET OFFSET	H INLET LENGTH	INLET CLOCK POSITION	OUTLET CLOCK POSITION
D99-0233	3.50	3.50	8X11	26.00	33.00	2.50	2.50	3.50	12.00	6.00
D13-6291	3.50	4.00	8x11	26.50	34.00	2.75	2.75	3.75	6.00	12.00
D13-6295	3.50	4.00	8x11	29.50	36.00	2.75	2.75	3.25	12.00	6.00
D13-2041	3.50	3.50	8x11	26.00	32.25	2.50	2.50	3.13	6.00	12.00
D99-0131	3.50	4.00	8X11	29.50	36.00	2.75	2.75	3.25	6.00	12.00
D99-0223	4.00	4.00	10.00	27.75	33.50	2.50	2.50	2.88	6.00	12.00
D13-2012	4.00	4.00	10x15	26.00	33.00	4.50	4.50	3.50	12.00	6.00
D13-6040	4.00	4.00	8x11	26.50	33.50	2.75	2.75	3.50	6.00	12.00
D13-6035	4.00	3.50	8x11	26.50	33.50	2.75	2.75	3.50	6.00	12.00
D13-2045	4.00	4.00	11.00	30.00	36.00	2.50	2.50	3.00	12.00	6.00
D13-1147	4.00	4.00	11.00	36.00	43.00	2.50	2.50	3.50	12.00	6.00
D13-2047	4.00	4.00	11.00	36.00	42.00	2.50	2.50	3.00	6.00	12.00
D99-0206	4.00	4.00	11.00	36.00	41.25	2.50	2.50	2.63	6.00	12.00
D13-4022	4.00	4.00	11.00	36.00	44.00	2.25	2.25	4.00	6.00	12.00
D99-0224	4.00	4.00	8X11	36.00	42.50	2.75	2.75	3.25	12.00	6.00
D13-7729	4.00	5.00	10x15	44.00	51.00	3.13	3.13	3.50	12.00	6.00
D13-4040	4.00	4.00	10.00	26.50	34.00	3.50	3.50	3.75	6.00	12.00
D13-7885	4.00	4.00	8X11	26.50	38.00	2.75	2.75	8.00	6.00	12.00
D12-2002	4.00	3.00	10.00	26.50	34.00	2.00	1.63	3.75	10:30	6.00
D13-4021	4.00	4.00	11.00	36.00	43.00	0.00	2.25	3.50	0.00	6.00
D99-0113	4.00	4.00	10.00	33.00	39.00	0.00	0.00	3.00	0.00	0.00
D99-0203	5.00	5.00	10X15	36.00	42.50	3.25	3.25	3.25	12.00	6.00
D13-2025	5.00	5.00	10x15	26.00	33.00	3.13	3.13	3.50	12.00	6.00
D13-2008	5.00	5.00	10x15	36.00	43.00	4.00	4.00	3.50	12.00	6.00
Q-200-10	5.00	5.00	8X11	26.50	34.50	2.50	2.50	3.50	12.00	6.00
D13-7599	6.00	6.00	10x15	31.50	42.50	3.60	3.60	5.50	12.00	6.00
D14-0083	6.00	6.13	10x15	27.50	38.00	3.75	3.75	3.50	12.00	6.00
D99-0261	8.00	8.00	12X18	26.00	38.00	4.50	4.50	7.25	12.00	6.00

ADDITIONAL MUFFLERS AVAILABLE ON SPECIAL ORDER TO ADDRESS CUSTOM APPLICATIONS

 ELBOWS
 STACKS

 RAIN CAPS
 & CLAMPS

 GUARDS
 & TUBING

 AIR INTAKE
 PARTS

 PERFORMANCE
 EXHAUST

 HOOD HOOKS
 & FENDERS

MUFFLERS

ELBOWS
STACKS

RAIN CAPS
& CLAMPS

GUARDS
& TUBING

AIR INTAKE
PARTS

PERFORMANCE
EXHAUST

HOOD HOOKS
& FENDERS

MUFFLERS

TYPE 3 DUEL END INLET / SINGLE END OUTLET

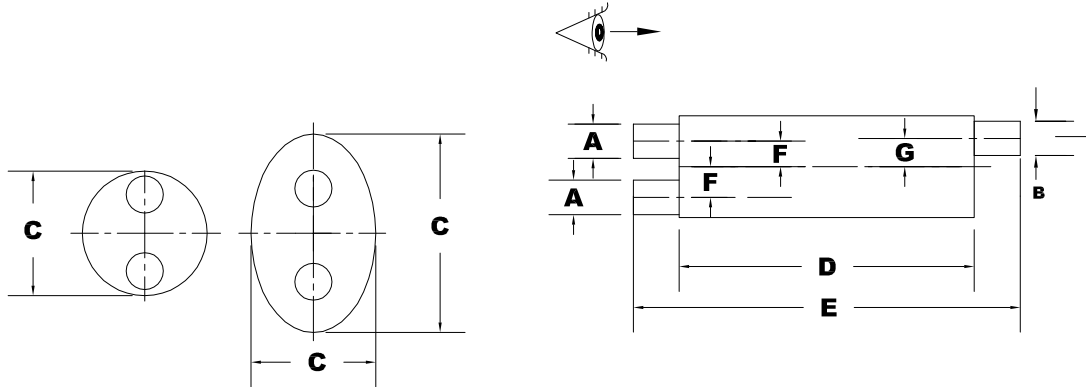

NOTE: ALL CLOCK POSITIONS ARE DETERMINED BY VIEWING THE MUFFLER FROM THE END VIEW, NEAREST THE INLET.

INLET-OUTLET CLOCK POSITIONS

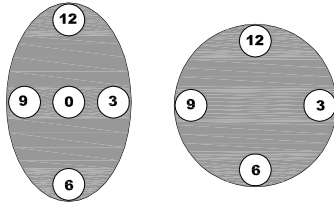

OVAL MUFFLER

ROUND MUFFLER

PART NUMBER	A INLET SIZE	B OUTLET SIZE	C BODY SIZE	D BODY LENGTH	E OVERALL LENGTH	F INLET OFFSET	G OUTLET OFFSET	H INLET LENGTH	INLET CLOCK POSITION	OUTLET CLOCK POSITION
D12-3260	2.5 FL/ 2.5 FL	3.00	8.50	29.50	38.50	1.25/1.8125	2.13	5.75	5&7	12.00
D99-0200	2.5 FL /2.5 FL	3.00	9.00	29.50	38.25	1.25 /1.81	2.13	5.625 & 3.125	7:30&4:30	12.00
D12-2275	2.5/2.5	2.75	8.50	29.50	39.00	1.25/1.8125	2.13	3.63	5&7	6.00
D12-3250	2.5/2.5	3.00	8.50	29.50	36.75	1.25/1.8125	2.13	3.88	5&7	12.00
D12-3255	2.5/2.5	3.00	8.50	37.00	44.00	1.25/1.8125	2.13	3.75	5&7	12.00
D13-1582	2.5/2.5	3.00	8x11	25.00	36.00	1.25/3	1.50	7.50	7&11	3.00
D12-0001	2.5/2.5	3.00	8x11	25.00	34.00	3/1.25	1.50	6.00	10&8	3.00
Q-007-14-409SS	2.5/2.5	3.00	8X11	25.00	34.00	1.25/3	1.50	6.00	6&12	3.00
D12-2270	2.5/2.5	2.50	7.00	30.00	37.50	1.94	1.50	3.75	3&9	12.00
D99-0130	2.75/2.75	4.00	8X11	26.50	33.00	2.75	3.50	3.00	0&12	12.00
D13-6001	2.75/2.75	4.00	8x11	26.50	33.00	.5/3.5	2.75	3.00	0&12	12.00

ADDITIONAL MUFFLERS AVAILABLE ON SPECIAL ORDER TO ADDRESS CUSTOM APPLICATIONS

TYPE 4 INLET AND OUTLET-SAME END

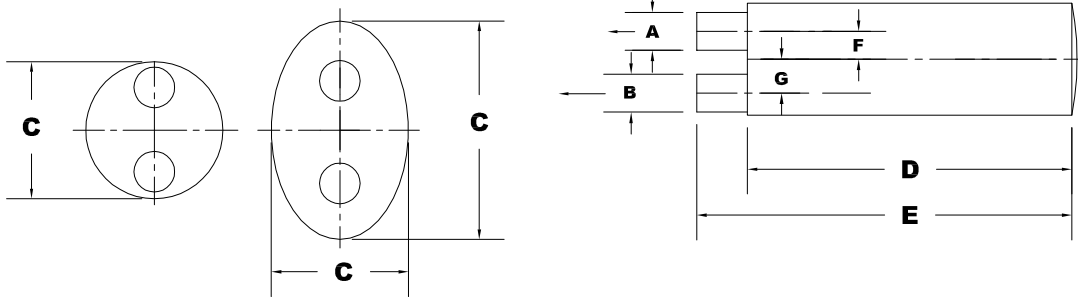
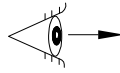

NOTE: ALL CLOCK POSITIONS ARE DETERMINED BY VIEWING THE MUFFLER FROM THE END VIEW, NEAREST THE INLET.

INLET-OUTLET CLOCK POSITIONS

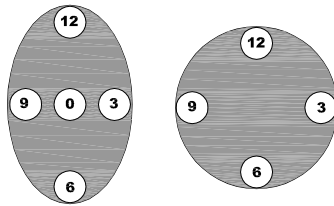

OVAL MUFFLER

ROUND MUFFLER

PART NUMBER	A INLET SIZE	B OUTLET SIZE	C BODY SIZE	D BODY LENGTH	E OVERALL LENGTH	F INLET OFFSET	G OUTLET OFFSET	H INLET LENGTH	INLET CLOCK POSITION	OUTLET CLOCK POSITION
D13-1161	3.50	4.00	8x11	30.50	34.00	2.63	2.63	3.50	12.00	6.00
D13-1093	3.50	4.00	8x11	32.00	35.50	2.50	2.50	3.50	12.00	6.00
D13-2006	4.00	4.00	10x15	26.00	29.50	4.00	4.00	3.50	12.00	6.00
D13-2017	4.00	4.00	10X15	27.75	30.88	2.25	2.25	3.13	12.00	6.00
D14-0163	4.00	5.00	10x15	44.00	47.50	4.00	4.00	3.50	6.00	12.00
D13-2007	5.00	5.00	10x15	36.00	39.00	4.00	4.00	3.00	6.00	12.00
D13-2011	5.00	5.00	10x15	26.00	29.50	3.00	3.00	3.50	12.00	6.00
D13-0102	5.00	5.00	10x15	44.00	47.50	3.50	3.50	3.50	6.00	12.00
D13-2090	5.00	5.00	10x15	44.00	47.50	4.00	4.00	3.50	12.00	6.00
Q-051-10	5.00	6.00	10X15	42.00	45.50	4.00	3.88	3.50	6.00	12.00
Q-052-10	5.00	6.00	10X15	42.00	45.50	4.00	3.88	3.50	6.00	12.00

ADDITIONAL MUFFLERS AVAILABLE ON SPECIAL ORDER TO ADDRESS CUSTOM APPLICATIONS

ELBOWS
STACKS

RAIN CAPS
& CLAMPS

GUARDS
& TUBING

AIR INTAKE
PARTS

PERFORMANCE
EXHAUST

HOOD HOOKS
& FENDERS

MUFFLERS

ELBOWS
STACKS

RAIN CAPS
& CLAMPS

GUARDS
& TUBING

AIR INTAKE
PARTS

PERFORMANCE
EXHAUST

HOOD HOOKS
& FENDERS

MUFFLERS

TYPE 6 SIDE INLET AND END OUTLET

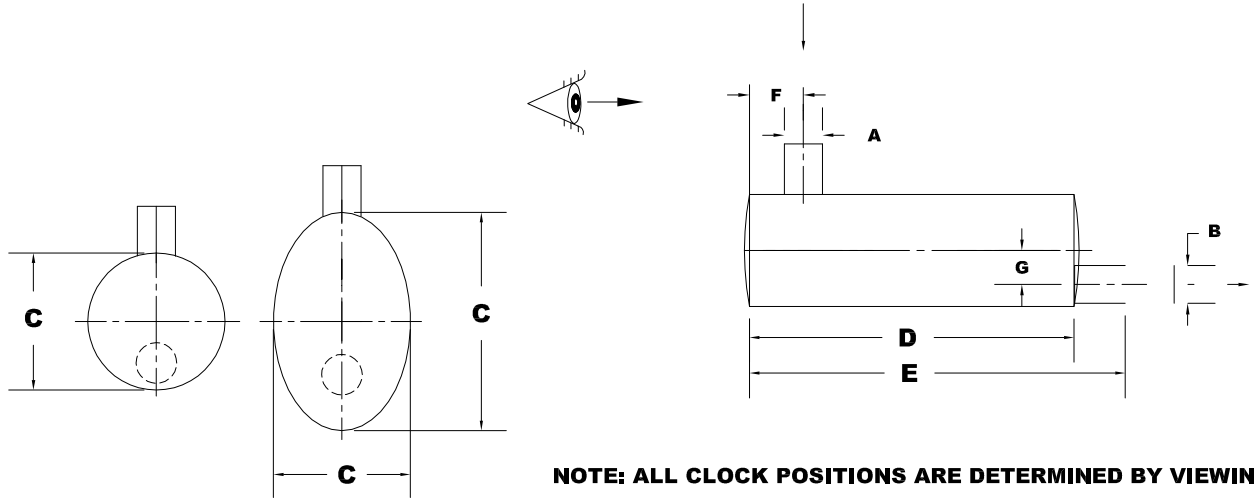

NOTE: ALL CLOCK POSITIONS ARE DETERMINED BY VIEWING THE MUFFLER FROM THE END VIEW, NEAREST THE INLET.

INLET-OUTLET CLOCK POSITIONS

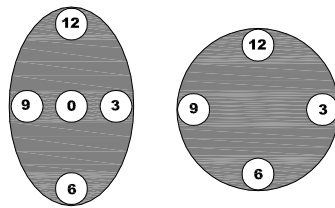

OVAL MUFFLER ROUND MUFFLER

PART NUMBER	A INLET SIZE	B OUTLET SIZE	C BODY SIZE	D BODY LENGTH	E OVERALL LENGTH	F INLET OFFSET	G OUTLET OFFSET	H INLET LENGTH	INLET CLOCK POSITION	OUTLET CLOCK POSITION
D99-0201	3.00	3.00	8.50	26.50	29.00	3.50	2.25	2.50	12.00	3.00
D99-0220	3.50	3.50	8X11	26.13	29.25	3.25	2.50	3.00	3.00	12.00
D13-7440	4.00	4.00	10X15	16.50	20.50	3.00	4.50	3.00	12.00	12.00
D13-2070	4.00	5.00	10X15	21.00	25.00	3.10	4.50	3.50	12.00	12.00
D99-0244	4.00	5.00	10X15	21.13	25.25	2.88	4.25	3.50	12.00	12.00
D13-0034	4.00	4.00	11.00	36.00	39.50	4.50	2.50	3.00	3.00	12.00
D99-0246	4.00	4.00	11.00	36.00	40.00	4.25	2.38	3.25	12.00	3.00
D13-7747	4.00	5.00	9.00	44.00	47.50	3.75	0.00	2.00	12.00	0.00
D13-7727	4.00	5.00	10X15	26.50	30.50	22.00	4.00	4.00	1.00	6.00
D13-1626	4.00	4.00	11.00	33.00	36.00	3.50	0.00	3.00	12.00	0.00
D99-0209	5.00	5.00	10X15	36.00	40.00	6.00	3.13	3.50	9.00	12.00
D13-5550	5.00	5.00	10.00	44.00	48.00	5.50	0.00	3.00	12.00	0.00
D13-0005	5.00	5.00	10X15	26.00	30.00	21.25	4.00	3.00	1.00	6.00
D99-0237	5.00	5.00	12.00	36.00	40.00	0.00	14.50	4.00	0.00	8.00
D13-7550	5.00	5.00	10X15	16.50	20.50	3.50	4.00	3.00	12.00	6.00
D13-7733	5.00	5.00	12X15	27.00	30.00	22.50	22.50	3.00	5.00	11.00

ADDITIONAL MUFFLERS AVAILABLE ON SPECIAL ORDER TO ADDRESS CUSTOM APPLICATIONS

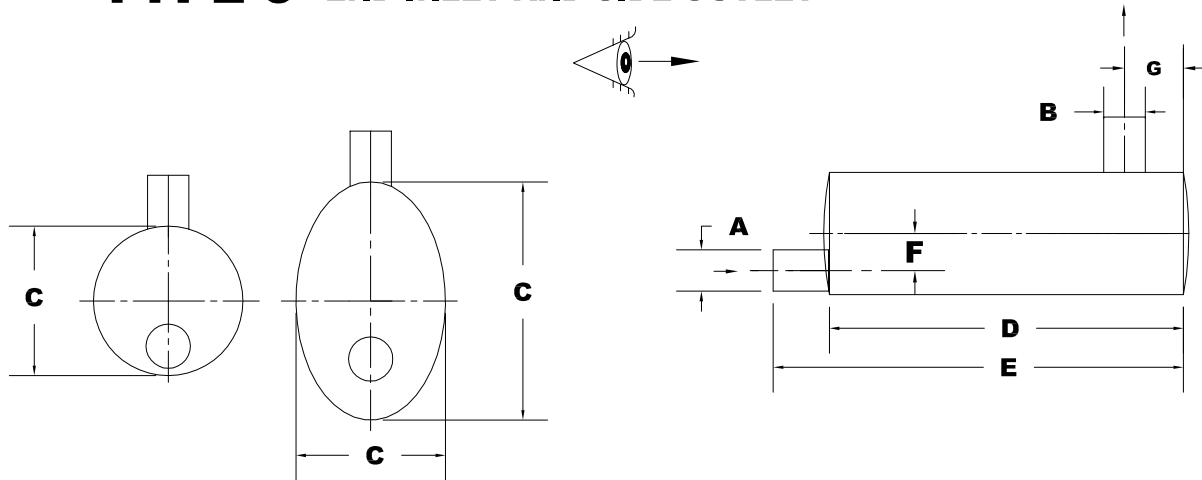
TYPE 9 END INLET AND SIDE OUTLET

NOTE: ALL CLOCK POSITIONS ARE DETERMINED BY VIEWING THE MUFFLER FROM THE END VIEW, NEAREST THE INLET.

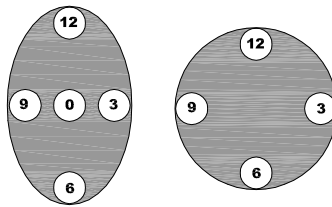
INLET-OUTLET CLOCK POSITIONS

OVAL MUFFLER
ROUND MUFFLER

PART NUMBER	A INLET SIZE	B OUTLET SIZE	C BODY SIZE	D BODY LENGTH	E OVERALL LENGTH	F INLET OFFSET	G OUTLET OFFSET	H INLET LENGTH	INLET CLOCK POSITION	OUTLET CLOCK POSITION
D13-6289	3.50	4.00	8x11	26.50	30.25	2.75	15.00	3.75	12.00	3:30
D13-0007	3.50	4.00	8x11	32.00	35.00	3.50	20.00	3.00	12.00	10.00
D13-7633	3.50	4.00	8x11	32.00	35.00	2.75	24.75	3.00	6.00	10:30
D13-0117	3.50	4.00	8x11	26.50	30.00	2.50	5.50	3.50	12.00	3:30
D13-1095	3.50	4.00	8x11	32.00	35.00	2.50	24.50	3.00	6.00	10.00
D13-6290	3.50	4.00	8x11	26.50	30.25	2.25	15.25	3.75	6.00	3.00
D13-1156	3.50	4.00	8x11	32.00	36.00	2.50	20.00	4.00	6.00	3:30
D99-0210	4.00	4.00	10.00	26.50	30.50	2.50	22.00	4.00	12.00	8.00
Q-319-11	4.00	4.00	10.00	28.00	30.75	0.00	24.25	2.75	0.00	12.00
D14-0123	4.00	4.00	10x15	36.00	40.50	3.75	29.00	4.50	6.00	12.00
D13-4023	4.00	4.00	11.00	36.00	39.50	1.50	28.50	3.50	6.00	12.00
D13-4285	4.00	4.00	10.00	26.50	30.50	3.50	7.25	3.50	6.00	11.00
D13-4104	4.00	4.00	10.00	36.00	40.00	3.50	6.00	4.00	6.00	12.00
Q-126-08	4.00	4.00	11.00	36.00	39.25	2.50	4.25	3.25	12.00	10.00
D13-7643	4.00	4.00	8x11	28.00	31.75	2.75	16.50	3.75	6.00	2.00
D13-7746	4.00	4.00	10x15	30.50	34.00	3.50	23.00	3.50	6.00	12.00
D14-0243	4.00	4.00	11.00	34.00	38.50	0.00	14.00	4.50	0.00	12.00
D13-1134	4.00	4.00	11.00	36.00	39.50	0.00	32.00	3.50	0.00	12.00
D14-0159	5.00	5.00	10x15	36.00	40.00	4.00	28.50	4.00	6.00	12.00
D13-2076	5.00	5.00	11.00	36.00	39.50	2.25	28.50	3.50	6.00	12.00
D13-0020	5.00	5.00	12.00	36.00	42.00	0.00	15.00	6.00	0.00	12.00
Q-250-10	5.00	5.00	10X15	21.88	25.38	4.00	7.25	3.50	6.00	12.00
D13-7887	5.00	5.00	9.00	22.00	26.50	5.00	1.50	23.50	12.00	12.00
D14-0008	5.00	6.15	10x15	19.00	23.00	4.00	13.50	3.75	6.00	12.00
Q-290-11	5.00	5.00	13.00	40.00	43.00	0.00	29.00	3.00	0.00	12.00

ADDITIONAL MUFFLERS AVAILABLE ON SPECIAL ORDER TO ADDRESS CUSTOM APPLICATIONS

 ELBOWS
 STACKS

 RAIN CAPS
 & CLAMPS

 GUARDS
 & TUBING

 AIR INTAKE
 PARTS

 PERFORMANCE
 EXHAUST

 HOOD HOOKS
 & FENDERS

MUFFLERS

TYPE 10 SIDE INLET AND SIDE OUTLET

ELBOWS
STACKS

RAIN CAPS
& CLAMPS

GUARDS
& TUBING

AIR INTAKE
PARTS

PERFORMANCE
EXHAUST

HOOD HOOKS
& FENDERS

MUFFLERS

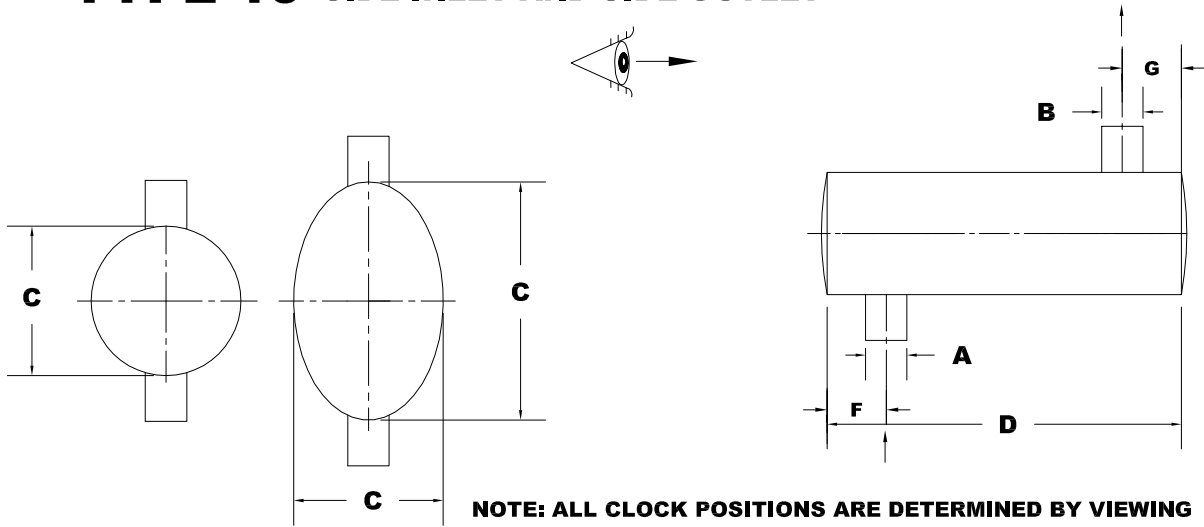

NOTE: ALL CLOCK POSITIONS ARE DETERMINED BY VIEWING THE MUFFLER FROM THE END VIEW, NEAREST THE INLET.

INLET-OUTLET CLOCK POSITIONS

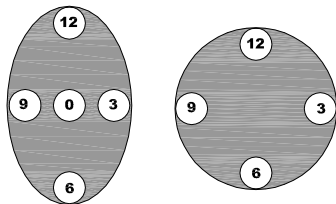

OVAL MUFFLER

ROUND MUFFLER

PART NUMBER	A INLET SIZE	B OUTLET SIZE	C BODY SIZE	D BODY LENGTH	E OVERALL LENGTH	F INLET OFFSET	G OUTLET OFFSET	H INLET LENGTH	INLET CLOCK POSITION	OUTLET CLOCK POSITION
D13-2085	4.00	4.00	11.00	36.00	36.00	4.00	13.50	3.00	12.00	2.00
Q-222-11	2.50	2.50	6.50	17.50	17.50	2.50	2.25	2.50	6.00	12.00
D99-0267	4.00	4.00	11.00	36.00	36.00	4.25	6.75	3.00	12.00	9.00
D13-0036	4.00	4.00	11.00	36.00	36.00	4.50	17.50	3.50	12.00	10:30
Q-143-12	2.50	2.50	6.50	18.00	18.00	2.50	2.50	3.00	9.00	12.00

ADDITIONAL MUFFLERS AVAILABLE ON SPECIAL ORDER TO ADDRESS CUSTOM APPLICATIONS

TYPE 12 END INLET / ASPIRATOR OUTLET

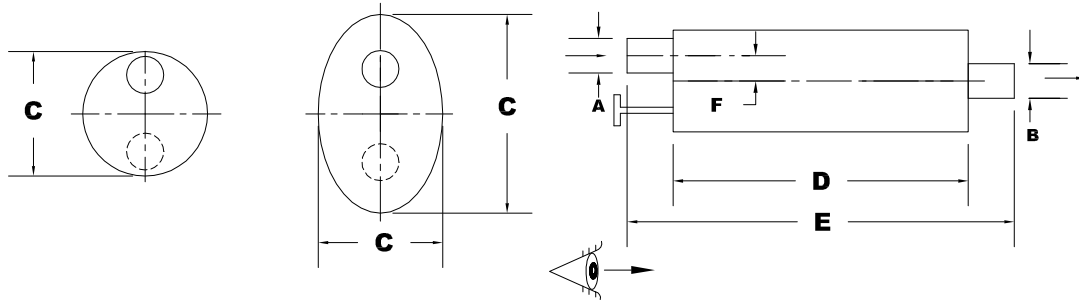
INLET-OUTLET CLOCK POSITIONS

NOTE: ALL CLOCK POSITIONS ARE DETERMINED BY VIEWING THE MUFFLER FROM THE END VIEW, NEAREST THE INLET.

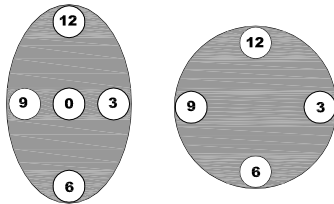

OVAL MUFFLER ROUND MUFFLER

PART NUMBER	A INLET SIZE	B OUTLET SIZE	C BODY SIZE	D BODY LENGTH	E OVERALL LENGTH	F INLET OFFSET	G OUTLET OFFSET	H INLET LENGTH	INLET CLOCK POSITION	OUTLET CLOCK POSITION
D14-0434	5.00	6.00	10x15	26.00	39.00	4.00	3.50	4.00	6.00	12.00

TYPE 13 END INLET / DUAL END OUTLET

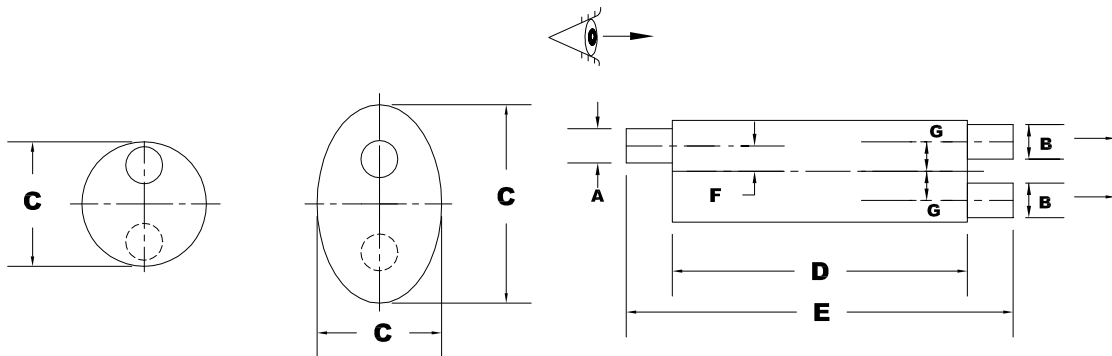
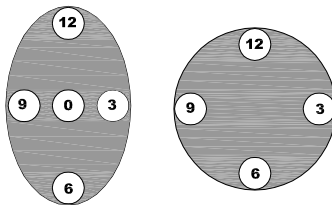
INLET-OUTLET CLOCK POSITIONS

OVAL MUFFLER ROUND MUFFLER

PART NUMBER	A INLET SIZE	B OUTLET SIZE	C BODY SIZE	D BODY LENGTH	E OVERALL LENGTH	F INLET OFFSET	G OUTLET OFFSET	H INLET LENGTH	INLET CLOCK POSITION	OUTLET CLOCK POSITION
D11-5302	3.00	3.00	4x11	14.75	20.75	0.00	3.00	3.00	0.00	12&6
D12-5002	3.00	2.25	4x11	23.00	28.00	0.00	3.00	2.50	0.00	12&6

ADDITIONAL MUFFLERS AVAILABLE ON SPECIAL ORDER TO ADDRESS CUSTOM APPLICATIONS

 ELBOWS
 STACKS

 RAIN CAPS
 & CLAMPS

 GUARDS
 & TUBING

 AIR INTAKE
 PARTS

 PERFORMANCE
 EXHAUST

 HOOD HOOKS
 & FENDERS

MUFFLERS

ELBOWS
STACKS

SPECIAL MUFFLERS

RAIN CAPS
& CLAMPS

GUARDS
& TUBING

AIR INTAKE
PARTS

PERFORMANCE
EXHAUST

HOOD HOOKS
& FENDERS

MUFFLERS

Stack Pipes for Industrial Equipment

Part Number	Description
D14-0558	Stack - 4ID x 40 Tip End with aspirator - Aluminized Steel
D14-0413	Stack - 5.125 x 36 - Aluminized Steel
D14-0555	Stack - 5.125 x 36 - Aluminized Steel
D14-0421	Stack - 5.17ID x 36 - Aluminized Steel
D14-0559	Stack - 5.876ID x 46.50 Pack Stack - Aluminized Steel
D14-0067	Stack - 5ID x 40.5 with aspirator - Aluminized Steel
D14-0426	Stack - 6.125 ID x 40 Tip End - Aluminized Steel
D14-0556	Stack - 6.15 ID x 44 - Aluminized Steel
D14-0009	Stack - 6.170 OD x 32 - Aluminized Steel
D14-0423	Stack - for 621E - Aluminized Steel

Splitter Tee Mufflers

- Economical way to convert a single system exhaust into a dual system.
- Produces low back pressure with an additional 3-5 dbA of exhaust noise control.

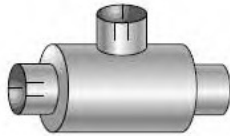

Part Number	Shell Diameter	Shell Length	Overall Length	Inlet I.D.	Outlet I.D.
D13-7613	10"	10"	21"	5"	5"

Wye Connector Mufflers

- Joins left and right hand exhaust pipes.
- Provides an additional 3 to 7 dbA exhaust noise reduction over that of the primary.

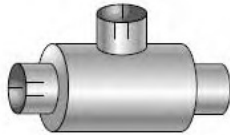

Part Number	Shell Diameter	Shell Length	Overall Length	Inlet I.D.	Outlet I.D.
D13-7612	7"	15"	18.5"	3"	4"
D13-7611	7"	15"	18.5"	3.5"	5"

Resonators

- Can reduce exhaust noise by 3 to 6 dbA.
- Most effective when installed in the exhaust pipe before the muffler.
- Straight through design does not increase back pressure, providing maximum service life.



Part Number	Body Diameter	Inlet and Outlet I.D.	Body Length	Overall Length
D16-0002	9"	5"	11.5"	16.25"
D16-0001	9"	4"	11.5"	16.25"
D16-0003	9"	3.5"	11.5"	16.25"
D13-7635	9"	3"	11.5"	16"

Universal

- When combined with our inlet and outlet patches, this universal muffler body can be made to match a wide variety of muffler styles.



Part Number	Body Diameter	Inlet and Outlet I.D.	Body Length	Overall Length
D99-0269	10"	-	36"	36"

T-shirt Mufflers

- Fits Freightliner Columbia .
- End inlet with dual side outlets.

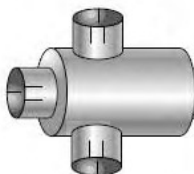

Part Number	Body Diameter	Inlet and Outlet I.D.	Body Length	Overall Length
Q-107-09	8x20"	5" ID	27.5"	30.5"

PERFORMANCE OVAL TYPE



Stormer Performer mufflers — Proven winners

- low, throaty growl on acceleration
- quiet purr at cruising speed
- easy flow design installation
- increased fuel economy
- fully welded assembly
- low back pressure
- versatile turbo style mufflers adapting to most vehicles
- heavy duty aluminized steel construction

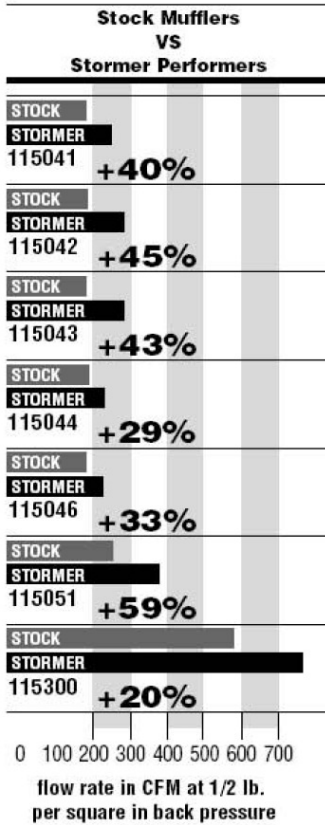

4.25" x 8.75" Oval / 13.25" Body

Part Number	Inlet	Outlet
D11-5041	2	2
D11-5042	2	2
D11-5043	2	2
D11-5044	2	2
D11-5046	2	2
D11-5051	2.25	2.25
D11-5052	2.5	2.5
D11-5053	2.25	2.25
D11-5054	2.25	2.25
D11-5055	2.5	2.5
D11-5056	2.5	2.5
D11-5175	2.25	2.25
D11-5176	2.25	2.25
D11-5208	1.75	1.75

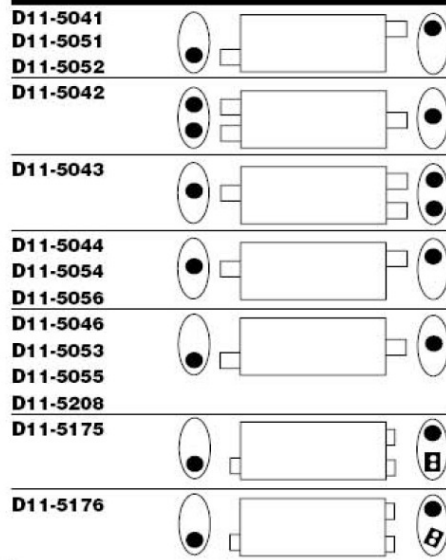

4.50" x 11" Oval / 14.75" Body

Part Number	Inlet	Outlet
D11-5100	2.25	2.25
D11-5202	2.25	2.25
D11-5300	3	3
D11-5301	3	3
D11-5302	3	3
D11-5303	3	3
D11-5304	3	3
D11-5305	3	2.50
D11-5306	3	2.50
D11-5803	2.25-3	2.25-3
D11-5828	2.25-3	2.25-3
D11-5852	2.5-3	2.25-3

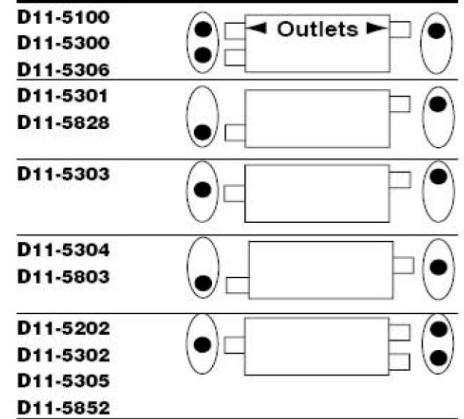

4.50" x 11" Oval / 22" Body

Part Number	Inlet	Outlet
D11-5900	2.125	2.125

D11-5900

ELBOWS
STACKS

RAIN CAPS
& CLAMPS

GUARDS
& TUBING

AIR INTAKE
PARTS

PERFORMANCE
EXHAUST

HOOD HOOKS
& FENDERS

MUFFLERS

ELBOWS
STACKS

RAIN CAPS
& CLAMPS

GUARDS
& TUBING

AIR INTAKE
PARTS

PERFORMANCE
EXHAUST

HOOD HOOKS
& FENDERS

MUFFLERS

Rabbit Performance Bottle Mufflers

- versatile performance mufflers to fit most vehicles
- aluminized steel construction
- fully welded assembly
- high flow design
- endurance mufflers that go the distance

Part Number	Inlet Size	Outlet Size	Body Length	Overall Length
D10-0103	2 ID	2 ID	12	21
D10-0113	2 ID	2 ID	17	25
D10-0114	2.25 ID	2.25 ID	17	25
D10-0117	3 ID	3 ID	17	25
D10-0118	2 ID	2.25 ID	17	25
D10-0119	2.50 ID	2.25 ID	17	25
D10-0123	2	2	24	32
D10-0124	2.25 ID	2.25 ID	24	32
D10-0203	2	2	12	21
D10-0204	2.25 ID	2.25 ID	12	21
D10-0213	2	2	17	25
D10-0214	2.25 ID	2.25 ID	17	25
D10-0290	3	2.25 ID	23	33.5
D10-0291	3	2.25 ID	23	33.75
D10-0900	1.75 ID	1.75 ID	10	15
D10-0902	2	2	10	15
D10-1000	2	2	16	22

D10-0103

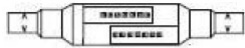

D10-0124



D10-0290

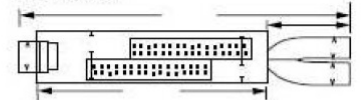

D10-0113



D10-0203



D10-0291

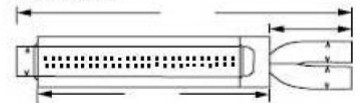

D10-0114 / D10-0118 / D10-0119



D10-0204



D10-0900 / D10-0902

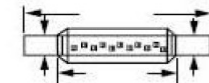

D10-0117



D10-0213



D10-1000

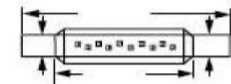

D10-0123



D10-0214

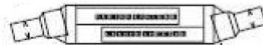



**CROSS
REFERENCE**

LONDON, ON 1-800-835-3831

RENO, NV 1-800-331-9247

NUMERICAL CROSS INDEX

Mfg. No.	Our No.	Mfg. No.	Our No.	Mfg. No.	Our No.
DONALDSON		M090547	D13-0007	86690M	D99-0093
M130076	Q-107-09	M090544	D13-0196	86685M	D13-7550
M122300	D13-7599	M090538	D13-6035	86682M	D13-0099
M120566	D13-2070	M090535	D99-0272	86672M	D13-2076
M120450	D13-2090	M090534	D13-6040	86655M	D13-0020
M120382	D13-7440	M090520	D13-6291	86626M	D13-5520
M120367	D13-7746	M090301	D99-0220	86624M	D13-7650
M120366	D14-0159	M090210	D13-2041	86597M	D13-7643
M120365	D99-0203	M090158	D13-2002	86594M	D12-2580
M120235	D99-0209	M090146	D13-3590	86570M	D13-0005
M120225	D13-2025	M090140	D14-0835	86561M	D14-0533
M120189	D13-2007	M090074	D13-5090	86560M	D13-7637
M120154	D13-2006	M090009	D13-2032	86556M	D99-0215
M120131	D13-2011	M085421	D99-0291	86547M	D13-4015
M120100	D13-2012	M085267	D99-0200	86544M	D13-4510
M111062	D16-0006	M085189	D12-3250	86542M	D13-2070
M111025	D14-0243	M085172	D12-2275	86537M	D13-0007
M110849	Q-044-09	M085171	D13-4060	86536M	D13-6295
M110824	D99-0301	M085090	D99-0201	86535M	D13-4515
M110482	D13-2085	M085056	D12-3030	86531M	D13-5510
M110479	D13-0034	M085023	D99-0221	86530M	D13-4023
M110311	D13-4023	M085023	D12-3430	86529M	D13-4022
M110189	D99-0206	M080018	D14-0289	86526M	D13-5550
M110143	D13-1157	M070228	D12-3347	86521M	D12-3430
M110014	D13-2076	M070050	D13-7595	86518M	D12-2240
M110012	D13-2045	M070008	D13-7593	86514M	D13-4095
M100807	D13-5520	M065142	Q-222-11	86512M	D13-6291
M100695	D13-4015	M065138	Q-198-12	86511M	D13-6289
M100582	D13-5511	M065065	D12-2575	86505M	D99-0224
M100580	D13-5510	M060307	D13-7602	86503M	D14-0159
M100466	D13-4510	M060232	D12-2220	86502M	D13-2047
M100465	D13-0099	NELSON		86500M	D13-2045
M100463	D13-5010	86777M	D13-1095	86353M	D99-0208
M100213	D13-5550	86775M	D13-2090	86305M	D13-7613
M100058	D13-7613	86774M	D13-1093	86221M	Q-126-08
M100052	D99-0210	86773M	D99-0271	86220M	D14-0123
M100049	D13-2017	86771M	D13-7747	86213M	D13-6035
M100048	D13-4040	86757M	D13-7733	86206M	D13-2041
M100043	D99-0223	86756M	D13-2085	86196M	D13-5511
M090823	D13-7747	86754M	D13-0117	86194M	D99-0209
M090781	D13-4095	86753M	D13-7729	86193M	D99-0220
M090680	D13-6295	86751M	D13-7727	86192M	D99-0201
M090595	Q-339-11	86727M	D13-0036	86189M	D13-1188
M090594	D13-7637	86725M	D99-0267	86188M	D13-3500
M090563	D13-6001	86724M	D13-0034	86187M	D13-7602
M090548	D13-6289	86722M	D99-0200	86186M	D13-7601

ELBOWS
STACKS

RAIN CAPS
& CLAMPS

GUARDS
& TUBING

AIR INTAKE
PARTS

PERFORMANCE
EXHAUST

HOOD HOOKS
& FENDERS

MUFFLERS



**CROSS
REFERENCE**

LONDON, ON 1-800-835-3831

RENO, NV 1-800-331-9247

**ELBOWS
STACKS**

**RAIN CAPS
& CLAMPS**

**GUARDS
& TUBING**

**AIR INTAKE
PARTS**

**PERFORMANCE
EXHAUST**

**HOOD HOOKS
& FENDERS**

MUFFLERS

NUMERICAL CROSS INDEX

Mfg. No.	Our No.	Mfg. No.	Our No.	Mfg. No.	Our No.
86185M	D13-6001				
86184M	D12-3250				
86183M	D12-2275				
86180M	D13-7599				
86175M	D13-2032				
86174M	D13-7595				
86173M	D13-7593				
86164M	D12-2350				
86153M	D13-6040				
86152M	D13-4104				
86151M	D99-0210				
86149M	D13-7440				
86148M	D13-4285				
86147M	D13-2025				
86141M	D12-3347				
86139M	D99-0221				
86137M	D12-2575				
86136M	D12-2220				
86135M	D12-3255				
86133M	D13-2017				
86132M	D99-0272				
86131M	D13-0196				
86130M	D13-5010				
86127M	D13-4060				
86125M	D13-2012				
86121M	D13-2011				
86118M	D99-0223				
86117M	D13-2008				
86116M	D13-2007				
86115M	D13-2006				
86113M	D13-3590				
86108M	D13-4590				
86106M	D99-0233				
86102M	D13-5090				
26612N	D14-0835				
201559N	Q-222-11				
20153T	D14-0289				
200238N	Q-339-11				

QUOTE SHEET

FAX: 519-681-9822

email: sales@shuttleworthexhaust.com



NAME:

COMPANY:

PHONE:

FAX:

EMAIL:

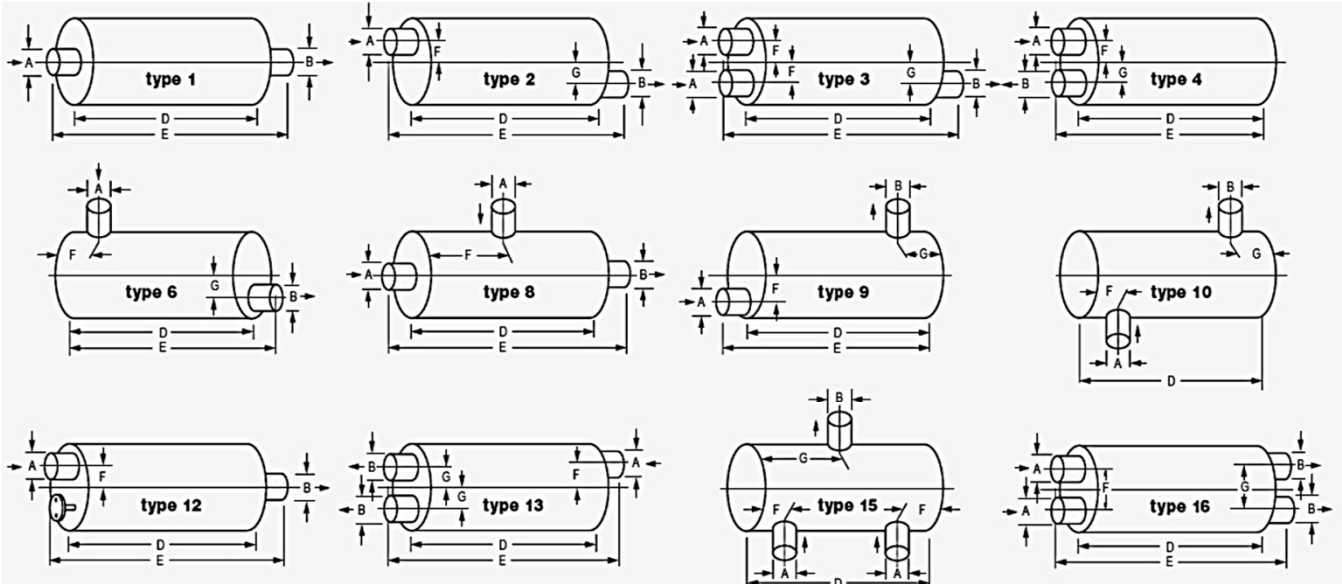

Note: view clock position from inlet end only.

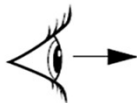

clock position

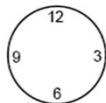

MUFFLER SPECIFICATIONS:

Quantity Required:

Engine Type, Size & Model:

Year, Make&Model of Vehicle:

OEM Number(muffler)/

Cross over Number:

Muffler Type:

Body Diameter:

Body Length (D):

Overall Length E:

Inlet Diameter (ID or OD) (A):

Outlet Diameter (ID or OD) (B):

Inlet (clock position):

Outlet (clock position):

Inlet Offset (F):

Outlet Offset (G):

Length of Inlet from Case:

Length of Outlet from Case:

Product Installation Information

Horizontal

Vertical

Method of Installation:

Free Standing

Cradle Support

Flange to Flange

Mounting Brackets

Other

(Location of Muffler Required for installation)

SHUTTLEWORTH

The Heavy Duty Exhaust Experts for Nearly 60 Years!

www.shuttleworthexhaust.com

For live customer service:

London, Ontario: 1-800-835-3831

Reno, Nevada: 1-800-331-9247

Shuttleworth Exhaust Canada (SES)

Shuttleworth Exhaust
3526 White Oak Road
London, ON N6E 2Z9
Canada

Tel: 1-800-835-3831
Tel: 1-519-681-1180
Fax: 1-519-681-9822

Shuttleworth Exhaust USA (SES USA)

Shuttleworth Exhaust
4910 Longley Lane Suite 103
Reno, NV 89502
USA

Tel: 1-800-331-9247
Tel: 1-775-827-3400
Fax: 1-775-827-1670

Fall 2015 Catalogue